



# P-DUKE POWER

## MAC15 Series

AC-DC POWER SUPPLIES  
Up to 15 Watts

**5**  
YEARS  
WARRANTY

ROHS  
COMPLIANT

REACH  
COMPLIANT

+85°C  
-40°C  
AMBIENT TEMP.

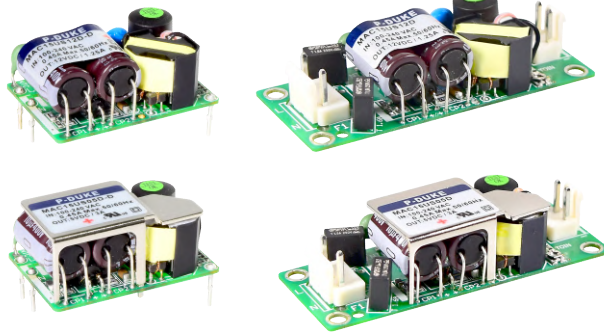

Medical



Automation



Datacom



IPC



Industry



Measurement



Telecom



Automobile



Boat



Charger



PV



Railway

UL US CB CE FC



**2**  
x  
MOPP

**4000**  
VAC  
Reinforced  
Insulation

**ADJ.**  
Output  
Voltage

Internal  
EN55032  
Class  
Filter **B**

**LOW**  
Leakage  
Current

**LOW**  
Standby  
Power

Operating  
Altitude  
**5000**  
meter

Protection  
Class I  
Class II

**OCP**

**OVP**

**SCP**

### PART NUMBER STRUCTURE

M	A	C	15	U	S	12	D	-	□
Application	Package Code	Dimension Code	Output Power (W)	Input Voltage (VAC)	Output Quantity	Output Voltage (VDC)	Protection Type		Connector Options
Medical Application	A: Open type			U: Universal 85 ~ 264	S: Single	3P3: 3.3 05: 5 7P5: 7.5 09: 9 12: 12 15: 15 18: 18 24: 24 28: 28 36: 36 48: 48 53: 53	D: CLASS II  □: CLASS I ※ B: CLASS II ※		□: JST M: Molex T: Terminal Block D: Pin Type* *(Only for CLASS II)

※NRND: Not recommended for new designs

**TECHNICAL SPECIFICATION** All specifications are typical at 230VAC input, full load and 25°C unless otherwise noted

Model Number	Input Range	Output Voltage	Output Current Natural Convection	Max. Output Power	Input Power @ No Load	Efficiency	Maximum Capacitor Load
	VAC	VDC	mA	W	mW	%	µF
MAC15US3P3D	85 ~ 264	3.3	4000	13.2	75	84	6000
MAC15US05D	85 ~ 264	5	3000	15	75	86	4000
MAC15US7P5D	85 ~ 264	7.5	2000	15	75	86	3000
MAC15US09D	85 ~ 264	9	1670	15	75	86	1860
MAC15US12D	85 ~ 264	12	1250	15	75	87	1200
MAC15US15D	85 ~ 264	15	1000	15	75	87	820
MAC15US18D	85 ~ 264	18	834	15	75	87	560
MAC15US24D	85 ~ 264	24	625	15	75	88	470
MAC15US28D	85 ~ 264	28	536	15	75	88	330
MAC15US36D	85 ~ 264	36	417	15	75	88	220
MAC15US48D	85 ~ 264	48	313	15	75	88.5	150
MAC15US53D	85 ~ 264	53	284	15	75	89	82

INPUT SPECIFICATIONS						
Parameter	Conditions	Min.	Typ.	Max.	Unit	
Operating input voltage range	AC input	85		264	VAC	
	DC input	120		370	VDC	
Input frequency	AC input	47		63	Hz	
Input current	100VAC and Full Load			0.45	A	
	240VAC and Full Load			0.30	A	
No load input power	230VAC		75		mW	
Leakage current	264VAC		75		µA	
Start up time	115VAC and Full Load		1500		ms	
Rise time			20		ms	
Hold up time	115VAC and Full Load		8		ms	
Input inrush current	230VAC(cold start)		40		A	
Input protection	Internal fuse		T1.6A/250VAC			

OUTPUT SPECIFICATIONS							
Parameter	Conditions	Min.	Typ.	Max.	Unit		
Output power				15	Watts		
Initial set voltage accuracy	230VAC and Full Load	-1.0		+1.0	%		
Line regulation	Low Line to High Line at Full Load	-0.2		+0.2	%		
Load regulation	No Load to Full Load			3.3Vout, 5Vout	-0.7	+0.7	%
				Others	-0.5	+0.5	
	10% Load to 90% Load			3.3Vout, 5Vout	-0.6	+0.6	%
				Others	-0.4	+0.4	
Voltage adjustability		-10		+10	%		
Minimum load			0		%		
Ripple and noise	Measured by 20MHz bandwidth With a 10µF/50V 1206 X5R MLCC			3.3Vout, 5Vout	40	mVp-p	
				7.5Vout, 9Vout, 12Vout, 15Vout	70		
	With a 1µF/100V 1206 X7R MLCC			18Vout, 24Vout, 28Vout, 36Vout	100		
				48Vout, 53Vout	140		
Temperature coefficient		-0.02		+0.02	%/°C		
Transient response	Load step from 75 ~ 100% change at 2.5A/µs	Peak deviation	5		%Vout		
		Recovery time	500		µs		
Over voltage protection	% of Vout(nom); Latch mode	115		140	%		
Over load protection	% of Iout rated; Hiccup mode		145		%		
Short circuit protection		Continuous, automatics recovery					

**GENERAL SPECIFICATIONS**

Parameter	Conditions		Min.	Typ.	Max.	Unit
Isolation voltage	1 minute (2MOPP insulation)	Input to Output	4000			VAC
Isolation resistance	500VDC		0.1			GΩ
Switching frequency	230VAC	MAC15USxxD MAC15USxx · MAC15USxxB		100 85		kHz
Safety approvals	IEC/ EN/ ANSI/AAMI ES 60601-1 IEC/ EN/ UL 62368-1				UL:E360199 UL:E193009 CB:UL(Demko)	
Weight		Connector type Pin type			19.0 (0.67oz) 16.5g (0.58oz)	
MTBF	MIL-HDBK-217F, Full load				3.063 x 10 <sup>6</sup> hrs	

**ENVIRONMENTAL SPECIFICATIONS**

Parameter	Conditions		Min.	Typ.	Max.	Unit
Operating ambient temperature	Natural convection	With derating	-40		+85	°C
Storage temperature range			-40		+85	°C
Operating altitude					5000	m
Shock					IEC60068-2-27	
Vibration					IEC60068-2-6	
Relative humidity	Non-condensing				5% to 95% RH	

**EMC SPECIFICATIONS**

Parameter	Conditions		Level		
EMI	EN55011, EN55032, EN60601-1-2, and FCC Part 18 / 15		Conducted		Class B
			Radiated		Class B
Harmonic currents	EN61000-3-2	Full Load			Class A
Voltage flicker	EN61000-3-3				
EMS	EN55035 and EN60601-1-2				
ESD	EN61000-4-2				Perf. Criteria A
Radiated immunity	EN61000-4-3	20 V/m			Perf. Criteria A
Fast transient	EN61000-4-4	± 2kV			Perf. Criteria A
Surge	EN61000-4-5	DM ± 1kV			Perf. Criteria A
Conducted immunity	EN61000-4-6	20 Vr.m.s			Perf. Criteria A
Power frequency magnetic field	EN61000-4-8	30 A/m			Perf. Criteria A
Dip and interruptions	EN61000-4-11				

### CHARACTERISTIC CURVE

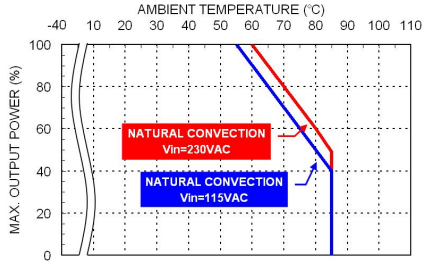

Derating Curve vs. Ambient Temperature  
MAC15USxxD xx=3P3/05/7P5/09/12/15/18  
Connector Option : (Blank: JST)

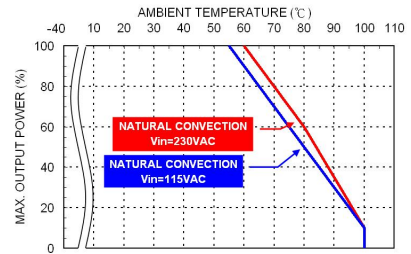

Derating Curve vs. Ambient Temperature  
MAC15USxxD xx=3P3/05/7P5/09/12/15/18  
Connector Option : (-M / -T / -D)

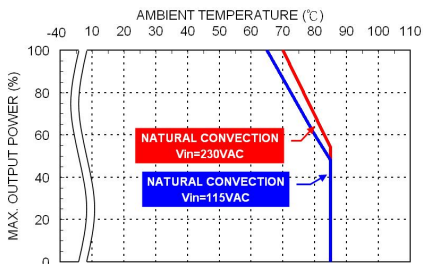

Derating Curve vs. Ambient Temperature  
MAC15USxxD xx=24/28/36/48/53  
Connector Option : (Blank: JST)

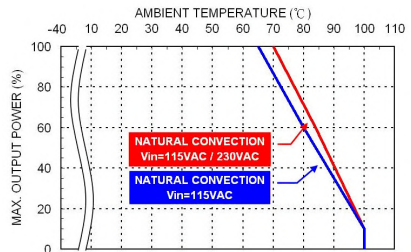

Derating Curve vs. Ambient Temperature  
MAC15USxxD xx=24/28/36/48/53  
Connector Option : (-M / -T / -D)

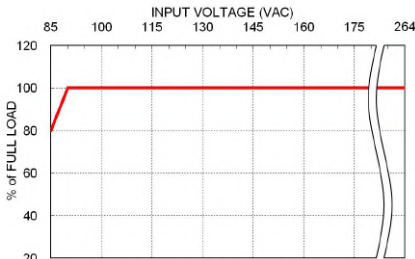

Derating Curve vs. Input Voltage

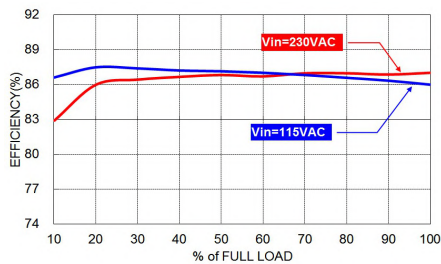

MAC15US12D Efficiency vs. Output Load

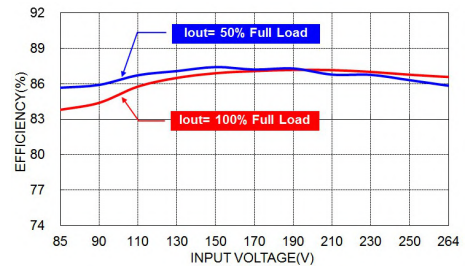

MAC15US12D Efficiency vs. Input Voltage

**MECHANICAL DRAWING**

**MAC15USxD Connector type**

\* Either one of four screw holes of Open / Chassis type can be considered as PE connection for CLASS I application.

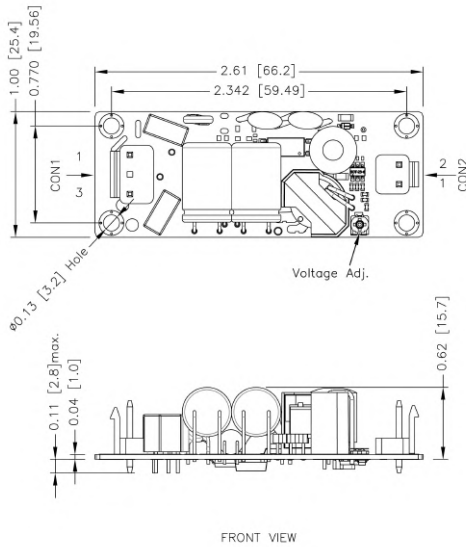

**CONNECTORS CONNECTION**

CON1 – Input Connector	
Pin 1	Line
Pin 3	Neutral

CON2 – Output Connector	
Pin 1	- Vout
Pin 2	+Vout

- All dimensions in inch [mm]  
Tolerance : x.xx±0.02 [x.x±0.5]  
              x.xxx±0.010 [x.xx±0.25]
- The screw locked torque: MAX 5.0kgf-cm/0.49N-m

**MAC15USxD Connector type with heat-sink assembly (For 3.3Vout, 5Vout, 9Vout)**

\* Either one of four screw holes of Open / Chassis type can be considered as PE connection for CLASS I application.

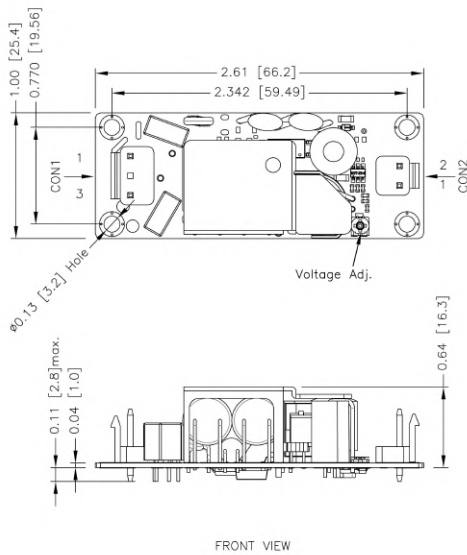

**CONNECTOR OPTIONS**

Blank:

JST Type

Housing  
CON1: **VHR-3N**  
CON2: **VHR-2N**



Crimp terminals  
CON1: **SVH-21T-P1.1**  
CON2: **SVH-21T-P1.1**

**-M**

Molex Type

Housing  
CON1: **09-50-8031**  
CON2: **09-50-8021**



Crimp terminals  
CON1: **SD-2478**  
CON2: **SD-2478**

USxxD **-T**

Terminal Block

Mates with  
Screw locked torque  
**MAX 2Kgf.cm/0.2N.m**



Wire dimension range  
**26 ~ 18AWG**

**MECHANICAL DRAWING**

MAC15USxxD –D Pin type

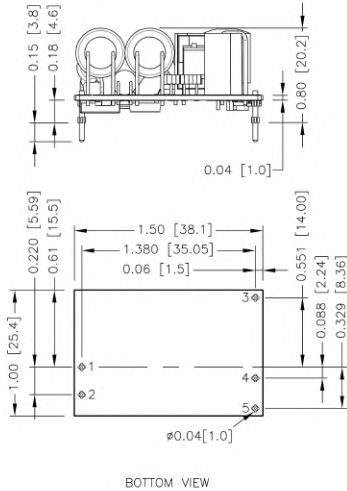

**PIN CONNECTION**

PIN	SINGLE
1	Line
2	Neutral
3	Trim
4	-Vout
5	+Vout

- All dimensions in inch [mm]  
Tolerance :x.xxx±0.02 [x.x±0.5]  
x.xxx±0.010 [x.xx±0.25]
- Pin pitch tolerance ±0.010 [0.25]
- Pin dimension tolerance ±0.004[0.10]

MAC15USxxD –D Pin type with heat-sink assembly (For 3.3Vout, 5Vout, 9Vout)

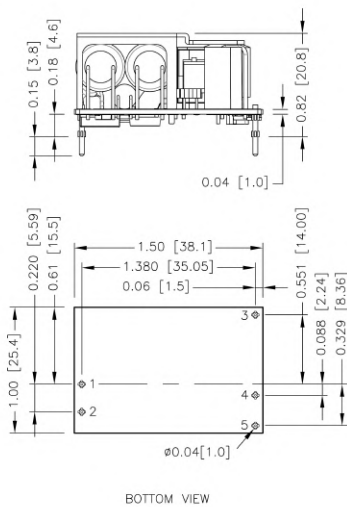

**RECOMMENDED PAD LAYOUT**

MAC15USxxD –D Pin type

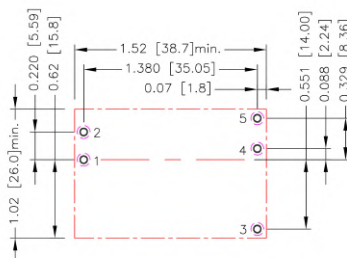

- All dimensions in inch[mm]  
Pad size(lead free recommended)  
Through hole 1.2.3.4.5:  $\Phi 0.051$ [1.30]  
Top view pad 1.2.3.4.5:  $\Phi 0.064$ [1.63]  
Bottom view pad 1.2.3.4.5:  $\Phi 0.102$ [2.60]

**MECHANICAL DRAWING**

**MAC15USxB Connector type**

\* Either one of four screw holes of Open / Chassis type can be considered as PE connection for CLASS I application.

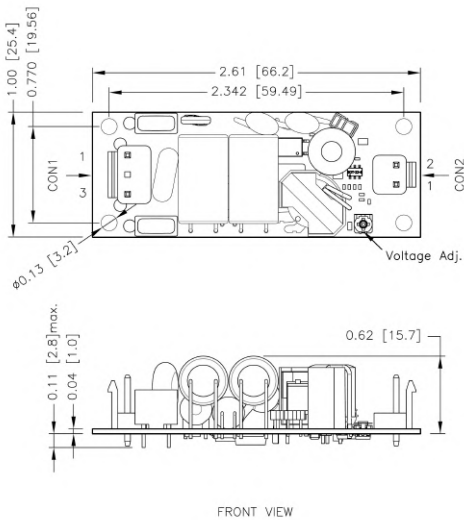

**CONNECTORS CONNECTION**

CON1 – Input Connector	
Pin 1	Line
Pin 3	Neutral

CON2 – Output Connector	
Pin 1	- Vout
Pin 2	+Vout



- All dimensions in inch [mm]  
Tolerance : x.xx±0.02 [x.xx±0.5]  
x.xxx±0.010 [x.xx±0.25]
- The screw locked torque: MAX 5.0kgf-cm/0.49N-m

**MAC15USxB Connector type with heat-sink assembly (For 3.3Vout, 5Vout, 9Vout)**

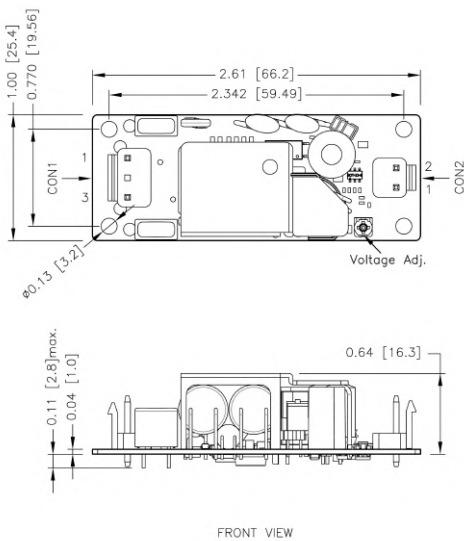
\* Either one of four screw holes of Open / Chassis type can be considered as PE connection for CLASS I application.



**CONNECTOR OPTIONS**

Blank:	JST Type	-M	Molex Type	-T	Terminal Block
	Housing CON1: <b>VHR-3N</b> CON2: <b>VHR-2N</b>		Housing CON1: <b>09-50-8031</b> CON2: <b>09-50-8021</b>		Mates with <b>Screw locked torque</b> <b>MAX 2Kgf.cm/0.2N.m</b>
	Crimp terminals CON1: <b>SVH-21T-P1.1</b> CON2: <b>SVH-21T-P1.1</b>		Crimp terminals CON1: <b>SD-2478</b> CON2: <b>SD-2478</b>		<b>Wire dimension range</b> <b>26 ~ 16AWG</b>

### MECHANICAL DRAWING

MAC15USxxB -D Pin type

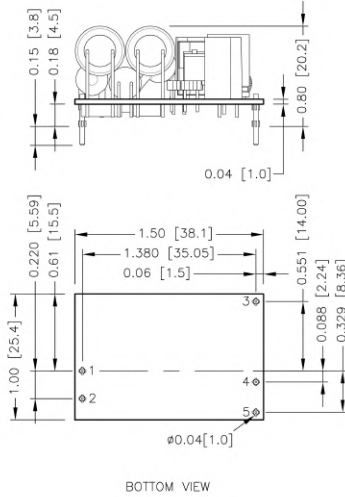

### PIN CONNECTION

PIN	SINGLE
1	Neutral
2	Line
3	Trim
4	-Vout
5	+Vout

- All dimensions in inch [mm]  
Tolerance :  $x.xxx \pm 0.02$  [ $x.x \pm 0.5$ ]  
 $x.xxx \pm 0.010$  [ $x.xx \pm 0.25$ ]
- Pin pitch tolerance  $\pm 0.010$  [0.25]
- Pin dimension tolerance  $\pm 0.004$  [0.10]

MAC15USxxB -D Pin type with heat-sink assembly (For 3.3Vout, 5Vout, 9Vout)

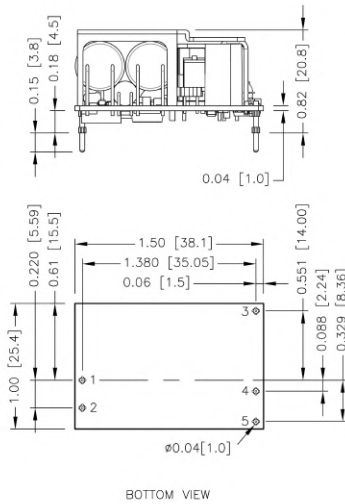

### RECOMMENDED PAD LAYOUT

MAC15USxxB -D Pin type

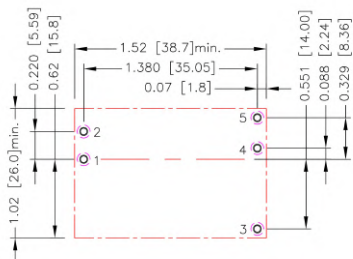

- All dimensions in inch [mm]  
Pad size (lead free recommended)  
Through hole 1.2.3.4.5:  $\Phi 0.051$  [1.30]  
Top view pad 1.2.3.4.5:  $\Phi 0.064$  [1.63]  
Bottom view pad 1.2.3.4.5:  $\Phi 0.102$  [2.60]



## OUTPUT VOLTAGE ADJUSTMENT

It allows the user to increase or decrease the output voltage of the module.

This is accomplished by connecting an external resistor between the Trim pin and either the +Vout or -Vout pins.

With an external resistor between the Trim and -Output pin, the output voltage increases.

With an external resistor between the Trim and +Output pin, the output voltage decreases.

The external Trim resistor needs to be at least 1/16W of rated power.

### Trim Up Equation

$$R_U = \left[ \frac{G \times L}{(V_{o,up} - L - K)} - H \right] \Omega$$

### Trim Down Equation

$$R_D = \left[ \frac{(V_{o,down} - L) \times G}{(V_o - V_{o,down})} - H \right] \Omega$$

### Trim Constants

Module	G	H	K	L
MAC15US3P3D-D	2000	2000	2.06	1.24
MAC15US05D-D	7500	2000	2.5	2.5
MAC15US7P5D-D	22000	2000	5	2.5
MAC15US09D-D	30000	2000	6.5	2.5
MAC15US12D-D	51000	2000	9.5	2.5
MAC15US15D-D	68000	2000	12.5	2.5
MAC15US18D-D	91000	2000	15.5	2.5
MAC15US24D-D	130000	2000	21.5	2.5
MAC15US28D-D	150000	2000	25.5	2.5
MAC15US36D-D	200000	2000	33.5	2.5
MAC15US48D-D	270000	2000	45.5	2.5
MAC15US53D-D	270000	2000	50.5	2.5

### EXTERNAL OUTPUT TRIMMING

Output can be externally trimmed by using the method shown below.

#### Trim-up

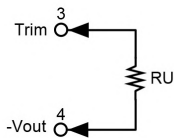

#### US3P3D-D

$\Delta V$ (%)	1	2	3	4	5	6	7	8	9	10
Vout (V)	3.333	3.366	3.399	3.432	3.465	3.498	3.531	3.564	3.597	3.630
RU (k $\Omega$ )	73.152	35.576	23.051	16.788	13.030	10.525	8.736	7.394	6.350	5.515

#### US05D-D

$\Delta V$ (%)	1	2	3	4	5	6	7	8	9	10
Vout (V)	5.050	5.100	5.150	5.200	5.250	5.300	5.350	5.400	5.450	5.500
RU (k $\Omega$ )	373.000	185.500	123.000	91.750	73.000	60.500	51.571	44.875	39.667	35.500

#### US7P5D-D

$\Delta V$ (%)	1	2	3	4	5	6	7	8	9	10
Vout (V)	7.575	7.650	7.725	7.800	7.875	7.950	8.025	8.100	8.175	8.250
RU (k $\Omega$ )	731.333	364.667	242.444	181.333	144.667	120.222	102.762	89.667	79.481	71.333

#### US09D-D

$\Delta V$ (%)	1	2	3	4	5	6	7	8	9	10
Vout (V)	9.090	9.180	9.270	9.360	9.450	9.540	9.630	9.720	9.810	9.900
RU (k $\Omega$ )	831.333	414.667	275.778	206.333	164.667	136.889	117.048	102.167	90.593	81.333

#### US12D-D

$\Delta V$ (%)	1	2	3	4	5	6	7	8	9	10
Vout (V)	12.120	12.240	12.360	12.480	12.600	12.720	12.840	12.960	13.080	13.200
RU (k $\Omega$ )	1060.500	529.250	352.167	263.625	210.500	175.083	149.786	130.813	116.056	104.250

#### US15D-D

$\Delta V$ (%)	1	2	3	4	5	6	7	8	9	10
Vout (V)	15.150	15.300	15.450	15.600	15.750	15.900	16.050	16.200	16.350	16.500
RU (k $\Omega$ )	1131.333	564.667	375.778	281.333	224.667	186.889	159.905	139.667	123.926	111.333

## OUTPUT VOLTAGE ADJUSTMENT(CONTINUED)

### Trim-up

US18D-D										
$\Delta V$ (%)	1	2	3	4	5	6	7	8	9	10
Vout (V)	18.180	18.360	18.540	18.720	18.900	19.080	19.260	19.440	19.620	19.800
RU (k $\Omega$ )	1261.889	629.944	419.296	313.972	250.778	208.648	178.556	155.986	138.432	124.389

US24D-D										
$\Delta V$ (%)	1	2	3	4	5	6	7	8	9	10
Vout (V)	24.240	24.480	24.720	24.960	25.200	25.440	25.680	25.920	26.160	26.400
RU (k $\Omega$ )	1352.167	675.083	449.389	336.542	268.833	223.694	191.452	167.271	148.463	133.417

US28D-D										
$\Delta V$ (%)	1	2	3	4	5	6	7	8	9	10
Vout (V)	28.280	28.560	28.840	29.120	29.400	29.680	29.960	30.240	30.520	30.800
RU (k $\Omega$ )	1337.286	667.643	444.429	332.821	265.857	221.214	189.327	165.411	146.810	131.929

US36D-D										
$\Delta V$ (%)	1	2	3	4	5	6	7	8	9	10
Vout (V)	36.360	36.720	37.080	37.440	37.800	38.160	38.520	38.880	39.240	39.600
RU (k $\Omega$ )	1386.889	692.444	460.963	345.222	275.778	229.481	196.413	171.611	152.321	136.889

  

US48D-D										
$\Delta V$ (%)	1	2	3	4	5	6	7	8	9	10
Vout (V)	48.480	48.960	49.440	49.920	50.400	50.880	51.360	51.840	52.320	52.800
RU (k $\Omega$ )	1404.250	701.125	466.750	349.563	279.250	232.375	198.893	173.781	154.250	138.625

US53D-D										
$\Delta V$ (%)	1	2	3	4	5	6	7	8	9	10
Vout (V)	53.530	54.060	54.590	55.120	55.650	56.180	56.710	57.240	57.770	58.300
RU (k $\Omega$ )	1271.585	634.792	422.528	316.396	252.717	210.264	179.941	157.198	139.509	125.358

### Trim-down

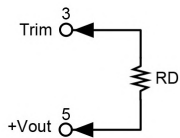

US3P3D-D										
$\Delta V$ (%)	1	2	3	4	5	6	7	8	9	10
Vout (V)	3.267	3.234	3.201	3.168	3.135	3.102	3.069	3.036	3.003	2.970
RD (k $\Omega$ )	120.848	58.424	37.616	27.212	20.970	16.808	13.835	11.606	9.872	8.485

US05D-D										
$\Delta V$ (%)	1	2	3	4	5	6	7	8	9	10
Vout (V)	4.950	4.900	4.850	4.800	4.750	4.700	4.650	4.600	4.550	4.500
RD (k $\Omega$ )	365.500	178.000	115.500	84.250	65.500	53.000	44.071	37.375	32.167	28.000

US7P5D-D										
$\Delta V$ (%)	1	2	3	4	5	6	7	8	9	10
Vout (V)	7.425	7.350	7.275	7.200	7.125	7.050	6.975	6.900	6.825	6.750
RD (k $\Omega$ )	1442.667	709.333	464.889	342.667	269.333	220.444	185.524	159.333	138.963	122.667

US09D-D										
$\Delta V$ (%)	1	2	3	4	5	6	7	8	9	10
Vout (V)	8.910	8.820	8.730	8.640	8.550	8.460	8.370	8.280	8.190	8.100
RD (k $\Omega$ )	2134.667	1051.333	690.222	509.667	401.333	329.111	277.524	238.833	208.741	184.667

US12D-D										
$\Delta V$ (%)	1	2	3	4	5	6	7	8	9	10
Vout (V)	11.880	11.760	11.640	11.520	11.400	11.280	11.160	11.040	10.920	10.800
RD (k $\Omega$ )	3984.500	1965.750	1292.833	956.375	754.500	619.917	523.786	451.688	395.611	350.750

US15D-D										
$\Delta V$ (%)	1	2	3	4	5	6	7	8	9	10
Vout (V)	14.850	14.700	14.550	14.400	14.250	14.100	13.950	13.800	13.650	13.500
RD (k $\Omega$ )	5596.667	2763.333	1818.889	1346.667	1063.333	874.444	739.524	638.333	559.630	496.667

**OUTPUT VOLTAGE ADJUSTMENT(CONTINUED)**

Trim-down

US18D-D										
$\Delta V$ (%)	1	2	3	4	5	6	7	8	9	10
Vout (V)	17.820	17.640	17.460	17.280	17.100	16.920	16.740	16.560	16.380	16.200
RD (k $\Omega$ )	7743.111	3825.056	2519.037	1866.028	1474.222	1213.019	1026.444	886.514	777.679	690.611

US24D-D										
$\Delta V$ (%)	1	2	3	4	5	6	7	8	9	10
Vout (V)	23.760	23.520	23.280	23.040	22.800	22.560	22.320	22.080	21.840	21.600
RD (k $\Omega$ )	11513.833	5690.917	3749.944	2779.458	2197.167	1808.972	1531.690	1323.729	1161.981	1032.583

US28D-D										
$\Delta V$ (%)	1	2	3	4	5	6	7	8	9	10
Vout (V)	27.720	27.440	27.160	26.880	26.600	26.320	26.040	25.760	25.480	25.200
RD (k $\Omega$ )	13508.714	6678.357	4401.571	3263.179	2580.143	2124.786	1799.531	1555.589	1365.857	1214.071

US36D-D										
$\Delta V$ (%)	1	2	3	4	5	6	7	8	9	10
Vout (V)	35.640	35.280	34.920	34.560	34.200	33.840	33.480	33.120	32.760	32.400
RD (k $\Omega$ )	18409.111	9103.556	6001.704	4450.778	3520.222	2899.852	2456.730	2124.389	1865.901	1659.111

US48D-D										
$\Delta V$ (%)	1	2	3	4	5	6	7	8	9	10
Vout (V)	47.520	47.040	46.560	46.080	45.600	45.120	44.640	44.160	43.680	43.200
RD (k $\Omega$ )	25321.750	12524.875	8259.250	6126.437	4846.750	3993.625	3384.250	2927.219	2571.750	2287.375

US53D-D										
$\Delta V$ (%)	1	2	3	4	5	6	7	8	9	10
Vout (V)	52.470	51.940	51.410	50.880	50.350	49.820	49.290	48.760	48.230	47.700
RD (k $\Omega$ )	25454.415	12591.208	8303.472	6159.604	4873.283	4015.736	3403.202	2943.802	2586.491	2300.642