

Relais statique monophasé de puissance

Single phase Power Solid State Relay

SU865770

Output : 24-510VAC 50A
Input : 18-30VAC/DC

→ Relais statique largeur 22,5mm entraxe de montage 47,6mm compatible boitier "hockey puck". Relais statique synchrone spécialement adapté à la plupart des charges.

22,5mm Pitch Solid State Relay for space-saving design. Mounting compatible with standard "hockey puck" SSRs (47,6mm between screws)

Zero Cross Solid State Relay especially designed for most types of loads.

→ Sortie thyristors technologie TMS²(*) permettant une longue durée de vie: 24 à 510VAC 50A. Haute Immunité et Protection de la tension de sortie par varistor. Très faible niveau de synchronisme.

Back to back thyristors on output with TMS² (*) technology with a long lifetime expectancy: 24 to 510VAC 50A. High Immunity and output voltage protection by VDR. Very low zero cross level

→ Commande 24VAC.
Connecteur de commande débrochable en 2 points
LED de visualisation sur l'entrée de couleur jaune.

Control voltage 24VAC
2 points pluggable control connector. Yellow LED visualization on the input.

→ Protection IP20 par volets amovibles sur les bornes.
Etiquette repère disponible en option.

IP20 protection by removable flaps on terminals with optional labels

→ Construit en conformité aux normes IEC/EN60947-4-3
et EN60950/VDE0805 ; IEC 60335-1/ VDE0700-1 ; UL-cUL

Designed in conformity with IEC/ EN60947-4-3
and EN60950/VDE0805 ; IEC 60335-1/
VDE0700-1 ; UL-cUL

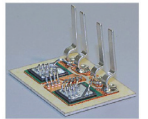

High Efficiency Thyristors

Livré avec connecteur de commande et volets / delivered with control connector and flaps



Avec étiquette de repérage en option
With optional labels

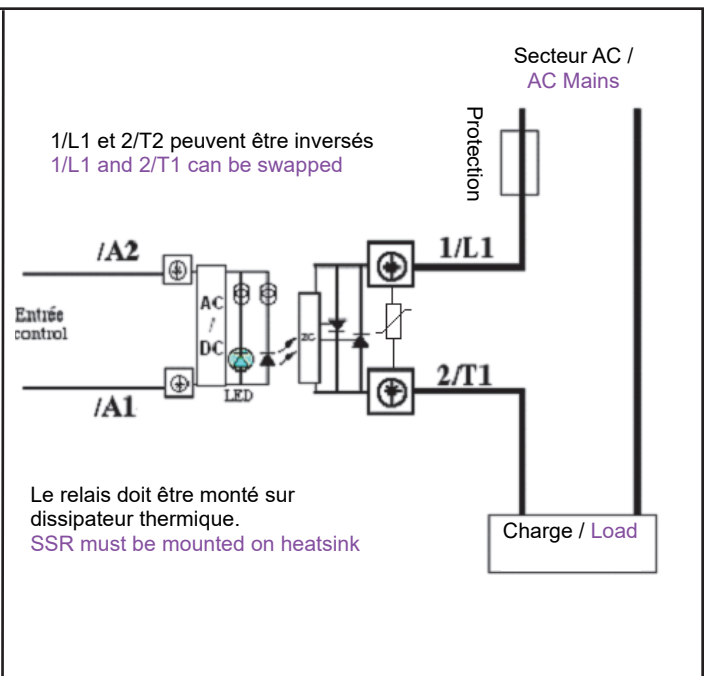
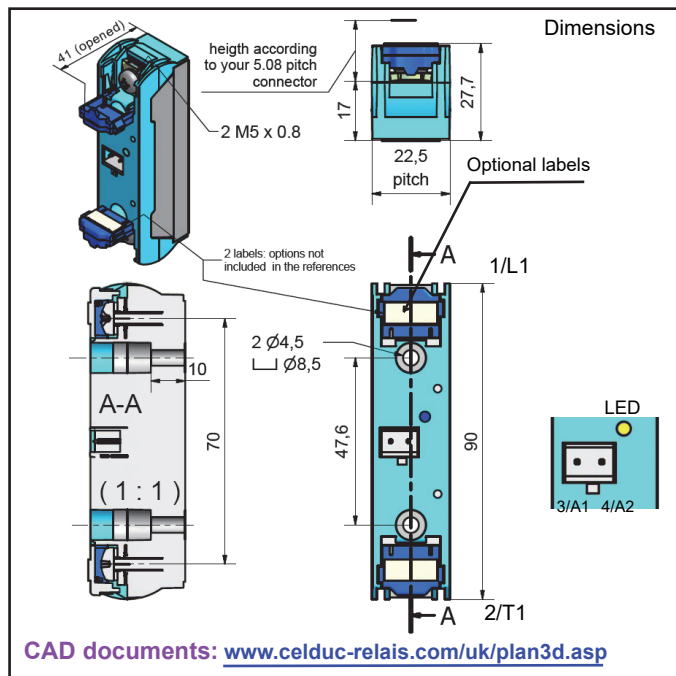

(*) TMS² =Thermo Mechanical Stress Solution

Proud to serve you

celduc®
r e l a i s

Caractéristiques d'entrée / Control characteristics (at 25°C)

Paramètre / Parameter	Symbol	AC/DC			Unit
		Min	Typ	Max	
Tension de commande / Control voltage	Uc	18	24	30	VAC
Courant de commande / Control current (@ Uc)	Ic	5.2	7.2	9.2	mA
Tension de non fonctionnement / Release voltage	Uc off	3			VAC
LED d'entrée / Input LED		Jaune/Yellow			
Immunité / Input immunity : EN61000-4-4		2kV			
Immunité / Input immunity : EN61000-4-5		2KV			

Input : Ic = f (Uc)

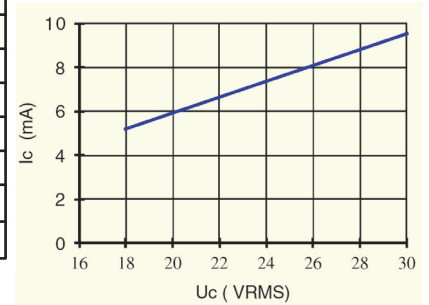

Caractéristiques de sortie / Output characteristics (at 25°C)

Paramètre / Parameter	Conditions	Symbol	Min	Typ.	Max	Unit
Plage de tension utilisation / Operating voltage range		Ue	24	400	510	V rms
Tension de crête / Peak voltage (clamping voltage)		Up	1200 (950)			V
Niveau de synchronisme / Zero cross level		U _{sync}			12	V
Tension minimum amorçage / Latching voltage	le nom	Ua	10			V
Courant nominal / nominal current (AC-51)	Heater	Ie AC-51		50	50	A rms
Courant nominal / nominal current (AC-53)	Motor	Ie AC-53		7	10	A rms
Courant nominal / nominal current (other loads)	Other loads	Ie	See page 5			
Courant surcharge / Non repetitive overload current	tp=10ms (Fig. 3)	I _{tsm}	530	580		A
Chute directe à l'état passant / On state voltage drop	(Ie = nominal current)	V	0.85 + 0,0075xIe			V
Tension seuil à l'état passant / On state Threshold voltage	@ 25°C	V _{to}			0.85	V
Résistance dynamique / On state dynamic resistance		r _t			7.5	mΩ
Puissance dissipée (max) / Output power dissipation (max value)		P _d	0.765 x Ie + 0,0075 x Ie ²			W
Résistance thermique jonction/semelle / Thermal resistance between junction to case		R _{thj/c}		0.6	0.75	K/W
Courant de fuite à l'état bloqué / Off state leakage current	@Ue typ, 50Hz	I _{lk}			1	mA
Courant minimum de charge / Minimum load current		I _{emin}	5			mA
Temps de fermeture / Turn on time	@Ue typ, 50Hz	t _{on max}			30	ms
Temps d'ouverture / Turn off time	@Ue typ, 50Hz	t _{off max}			30	ms
Fréquence réseau/ Mains frequency range	F mains	f	0,1	50-60	800	Hz
dv/dt à l'état bloqué / Off state dv/dt		dv/dt	500			V/μs
di/dt max / Maximum di/dt non repetitive		di/dt			50	A/μs
I _{2t} (<10ms) : Value for fusing		I ² _t	1404	1680		A ² s
Immunité / Conducted immunity level	IEC/EN61000-4-4 (bursts)		2kV criterion A			
Immunité / Conducted immunity level	IEC/EN61000-4-5 (surge)		2kV criterion A			
Protection court-circuit / Short circuit protection	coordination typ 2	see page 5	Fuse Ferraz gRC 40A 22x58			

Caractéristiques générales / General characteristics (at 25°C)

Isolement entrée/sortie - Input to output insulation	Ui	4000	VRMS
Isolation sortie/ semelle - Output to case insulation	Ui	4000	VRMS
Résistance Isolement / Insulation resistance	Ri	1000 (@500VDC)	MΩ
Tenue aux tensions de chocs / Rated impulse voltage	Uimp	4000	V
Degré de protection / Protection level / CEI529		IP20	
Degré de pollution / Pollution degree	-	2	
Vibrations / Vibration withstand 10 -150 Hz according to IEC 60068-2-6	sine test	10	g
Tenue aux chocs / Shocks withstand according to IEC 60068-2-27	11ms	> 30 50	g
Température de fonctionnement / Ambient temperature (no icing, no condensation)	-	-55 /+100	°C
Température de stockage/ Storage temperature (no icing, no condensation)		-55/+125	°C
Humidité relative / Ambient humidity	HR	40 to 85	%
Poids/ Weight		80	g
Conformité CE / CE Conformity		IEC/ EN60947-4-3	
Conformité USA / US Conformity		UL/cUL	
Conformité normes ferroviaires/ Conformity to railways applications		yes (consult us)	
Plastique du boîtier / Housing Material		PA 6 UL94V0	
Semelle / Base plate		Aluminium	



Fig. 2 Courbes thermiques & Choix dissipateur thermique / Thermal curves and heatsink choice

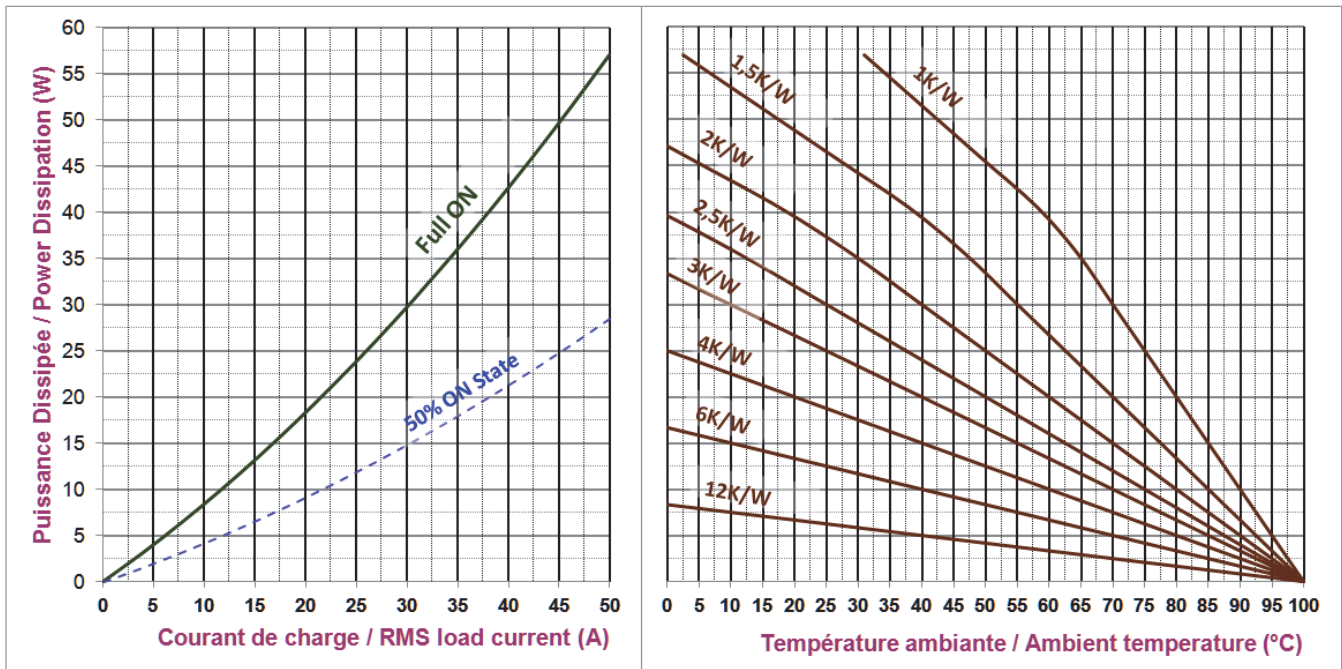

Dissipateurs celduc standard/ Standard celduc heatsinks:
 - WF311100 = 3K/W (2.8-3.5K/W)
 - WF151200 = 2K/W (2-2.5K/W)
 - WF112100 = 1K/W (0.8-1.2K/W)

fig 3 : Courants de surcharges / Overload currents

- 1 - **Its_m non répétitif** sans tension réappliquée est donné pour la détermination des protections.
 1 - **No repetitive Its_m** is given without voltage reappplied .
 This curve is used to define the protection (fuses).
- 2 - **Its_m répétitif** est donné pour des surcharges de courant (T_j initiale=70°C).
 Attention : la répétition de ces surcharges de courant diminue la durée de vie du relais.
 2 - **Repetitive Its_m** is given for inrush current with initial T_j = 70°C. In normal operation, this curve musn't be exceeded.
 Caution, frequent over load currents will decrease the life expectancy of the SSR.

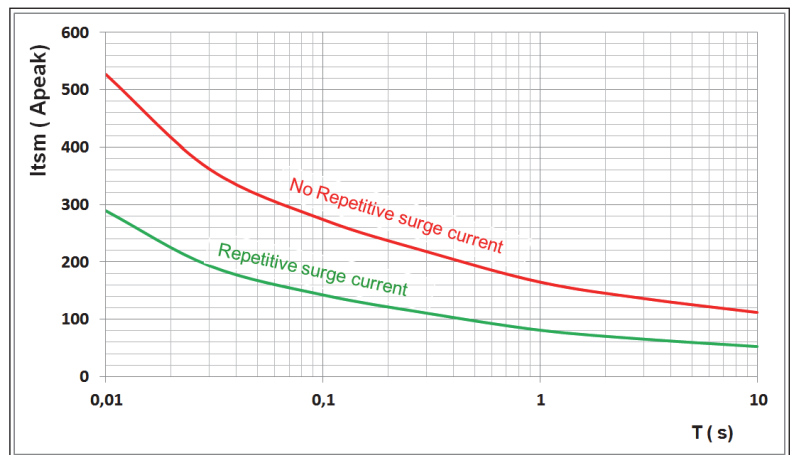

→ Attention ! les relais à semi-conducteurs ne procurent pas d'isolation galvanique entre le réseau et la charge. Ils doivent être utilisés associés à un disjoncteur avec propriété de sectionnement ou similaire, afin d'assurer un sectionnement fiable en amont de la ligne dans l'hypothèse d'une défaillance et pour tous les cas où le relais doit être isolé du réseau (maintenance; non utilisation sur une longue durée...).





Sous réserve d'installation, d'entretien et d'utilisation conformes à sa destination, à la réglementation, aux normes en vigueur, aux instructions du constructeur et aux règles de l'art.

→ Warning ! semiconductor relays don't provide any galvanic insulation between the load and the mains. Always use in conjunction with an adapted circuit breaker with insulation feature or a similar device in order to ensure a reliable insulation in the event of wrong function and when the relay must be insulated from the mains (maintenance ; if not used for a long duration ...).

It is important that the solid state relay is subject to correct installation, maintenance and use conforming to its intended regulations and standards, to the supplier's instructions and to accepted rules of art.



Raccordement / Connections

celpac® Raccordement de puissance / Power wiring				Modèle de tournevis / Screwdriver type	Couple de serrage recommandé Vis M5 Recommended tightening torque M5 screw N.m
Nombre de fils / Number of wires Directement avec fils avec ou sans embouts Direct connection with wires with or without ferrules					
1		2			Mini 2 / Typ 2.4 / Max 3
Fil rigide (sans embout) SOLID (No ferrule)	Fil multibrins (avec embout) FINE STRANDED (With ferrule)	Fil rigide (sans embout) SOLID (No ferrule)	Fil multibrins (avec embout) FINE STRANDED (With ferrule)		
					
1,5 ... 10 mm ² AWG16...AWG8	1,5 ... 6 mm ² AWG16...AWG10	1,5 ... 10 mm ² AWG16...AWG8	1,5 ... 6 mm ² AWG16...AWG10	POZIDRIV 2	

Puissance (M5) / Power (M5)

Avec cosses/ With ring terminals

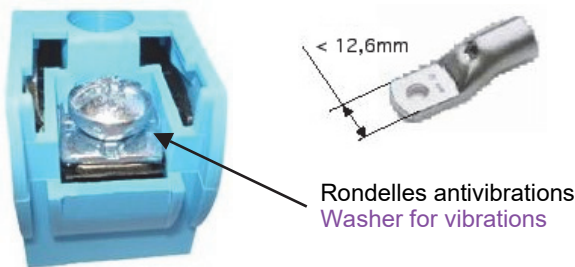

Commande / Control

→ Le relais SU est livré en standard avec un connecteur de commande 2 points débrochable référence **celduc** 1Y020915 / Weidmuller BLZ5,08/2/90SN SW code 155 271 0000.

Raccordement de fils : 0,13 ... 3,3 mm² / AWG26...AWG12

Tournevis plat

Autres modèles (ressorts...) : Voir détails page 5

SU relay is delivered in standard with a pluggable control connector with a **celduc** reference 1Y020915 /

Weidmuller BLZ5,08/2/90SN SW code 155 271 0000.

Wiring : 0,13 ... 3,3 mm² / AWG26...AWG12

Flat Screwdriver

Other possible connectors on request (spring.....) See details page 5.

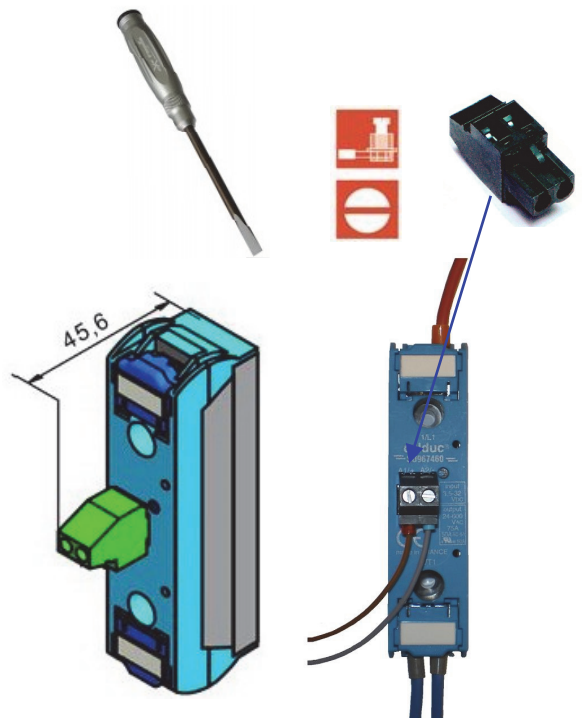

Options /Options:

→ Des étiquettes de repérage sont disponibles. Montage sur volet.

Référence 1MZ09000. Quantités par 200 pièces

Marking labels are available . Mounting on flaps

Part number : 1MZ09000 (delivered per 200 parts)

→ Versions prémontées sur dissipateurs : SUL en 22,5mm, SUM en 45mm, SUH en 50mm

Ready to use versions (with heatsink) SUL (22,5mm); SUM (45mm), SUH (50mm)

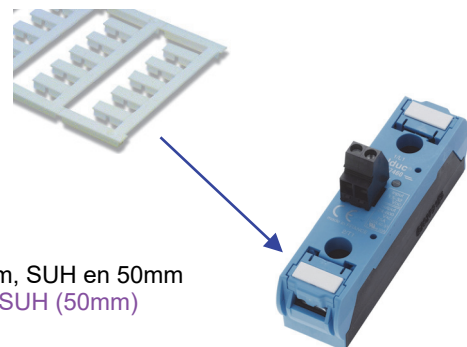

**Connecteurs de commande en option /
Optional input connectors**

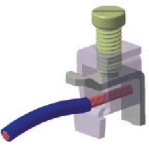
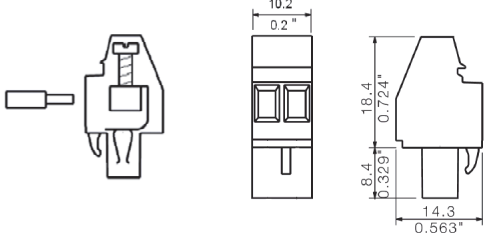
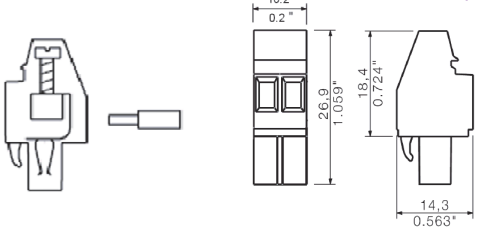
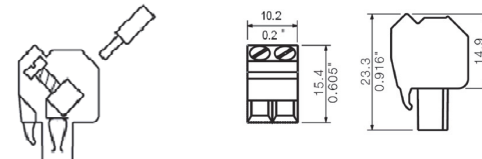
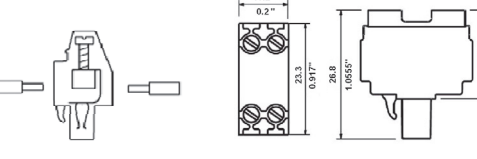
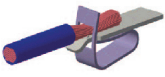
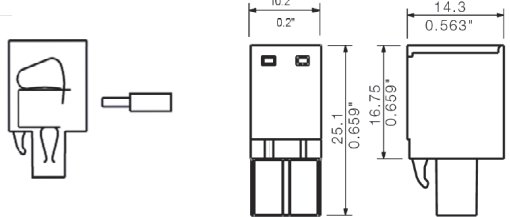
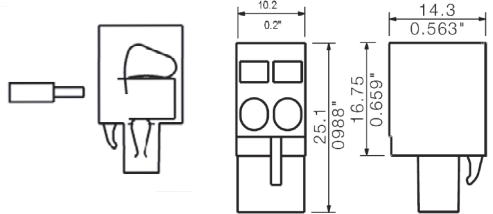
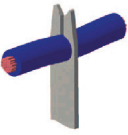
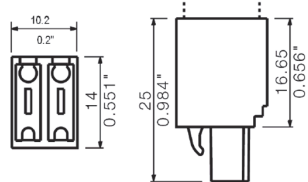
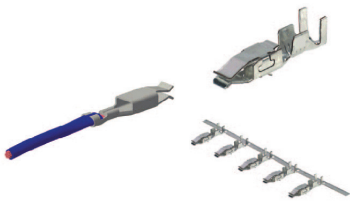
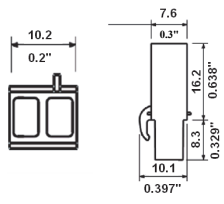
<p>Connecteur à vis Screw solution</p>  <p>Single wire = 0,15...2,5mm² 26-12AWG Wire strip length = 7mm</p>	<p>1 screw 90° Monté en standard/ Mounted in standard</p>  <p>Ref : 1Y020915 Weidmuller: BLZ5,08/2/90SN SW</p>	<p>2 screw 270° Sur demande/ On request</p>  <p>Ref : 1Y022715 Weidmuller: BLZ5,08/2/270SN SW</p>
	<p>3 Screw 45° Sur demande/ On request</p>  <p>Ref : 1Y022217 Weidmuller: BLZ5,08/2/225SN SW</p>	<p>4 double Sur demande/ On request</p>  <p>Ref : 1Y021660 Weidmuller: BLDT5,08/2 SN SW</p>
<p>Solution ressort Spring solutions</p>  <p>Single wire = 0,15...2,5mm² 26-12AWG Wire strip length = 10mm</p>	<p>5 270° Sur demande/ On request</p>  <p>Ref : 1Y022716 Weidmuller: BLZF5,08/2/270 SW</p>	<p>6 90° Sur demande/ On request</p>  <p>Ref : 1Y020916 Weidmuller: BLZF5,08/2/90 SW</p>
<p>Insulation Displacement Connection</p> <p>Weidmuller: BLIDC</p>  	<p>Cosses Crimp solutions</p> <p>Weidmuller: BLC</p>  	

CAD documents: www.celduc-relais.com/uk/plan3d.asp



