

**MOSFET BASED  
DC SOLID-STATE RELAY**  
*(With built-in transient voltage suppressor)*

- ▶ Latest MOSFET technology generation.
- ▶ Ultra low on-state resistance.
- ▶ Low output leakage current.
- ▶ Low control current consumption.
- ▶ Built-in overvoltage protection (TVS)
- ▶ Reverse protected triggered control input to avoid linear control risks
- ▶ No radiated or conducted disturbances
- ▶ Touch protected housing IP20



**SOM06075**



Control voltage range	3.5-32VDC
Max transient peak voltage	75v
Max. DC Mains peak voltage	40VDC
Max. Load Current (with heatsink)	60ADC

DC Mains voltage range	Load current range	Control input voltage range	In & case / Out Insulation	Connections	Dimensions (WxHxD)	Weight
5-40VDC (75Vpeak)	Up to 60A (with heatsink)	3.5-32VDC	2.5kV	Screw terminals	45 x 58.5 x 30	80g

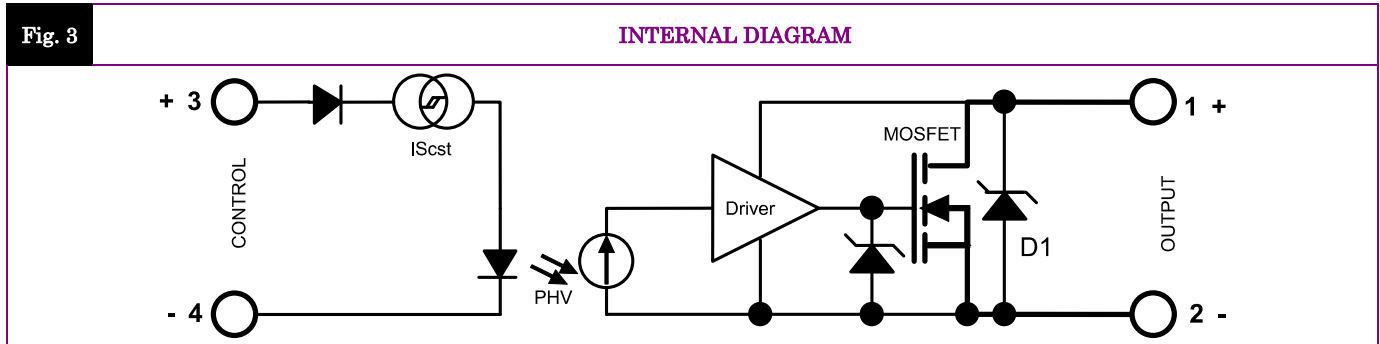
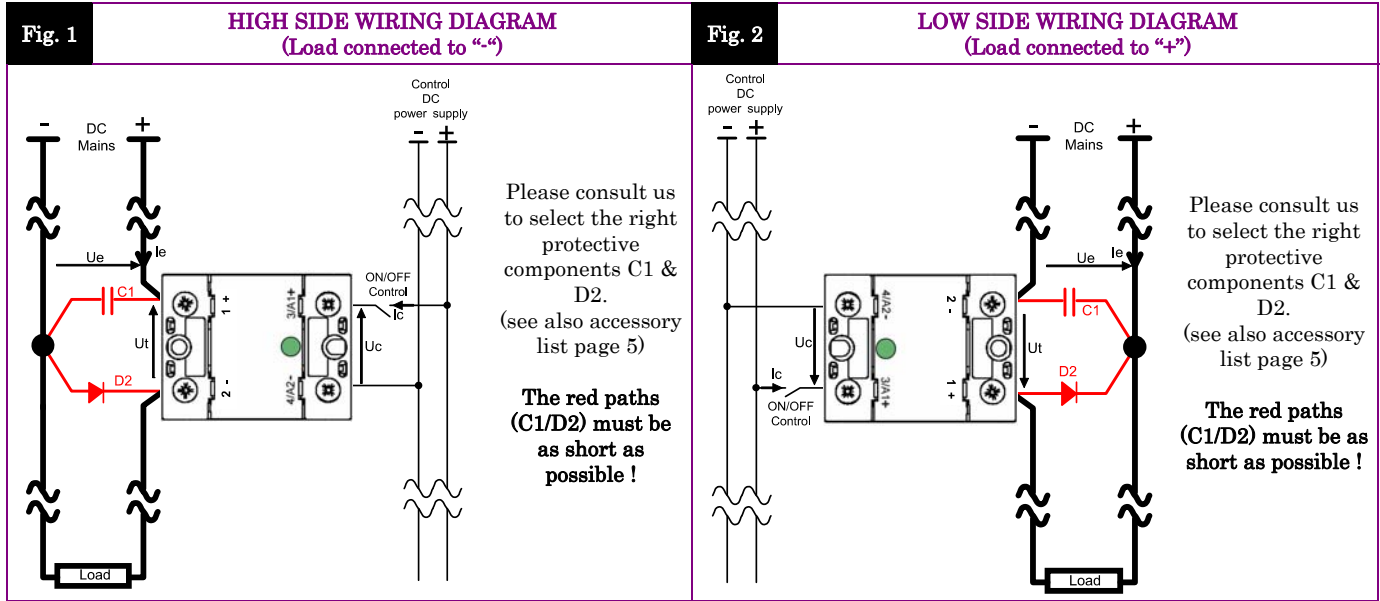

*Proud to serve you*

**CONTROL INPUT CHARACTERISTICS**

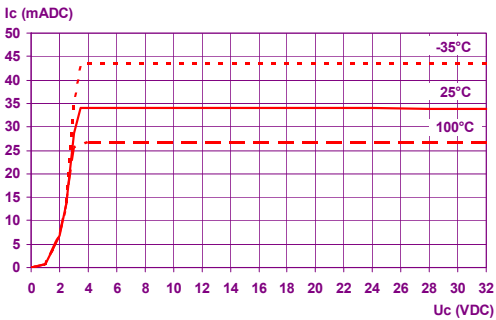
INPUT CIRCUIT	CHARACTERISTIC	LABEL	VALUE	INFO.	<b>Fig. 4</b> <b>CONTROL CURRENT vs. CONTROL VOLTAGE</b> 
	Nom. Control voltage	<b>U<sub>Cnom</sub></b>	12-24VDC		
	Nom. Control current	<b>I<sub>Cnom</sub></b>	35mADC	-100µA/°C	
	Control voltage range	<b>U<sub>c</sub></b>	3.5 – 32VDC	typical=3.3V	
	Control current consumption	<b>I<sub>c</sub></b>	32 – 35mADC	See curve	
	Releasing control voltage	<b>U<sub>Coffmax</sub></b>	1VDC	Typical= 2.6V	
	Max. reverse control voltage	<b>-U<sub>Cmax</sub></b>	32VDC	-I <sub>cmax</sub> <100µA	
	Input impedance	<b>R<sub>in</sub></b>	Current limitation	See curve	

**TIME CHARACTERISTICS**

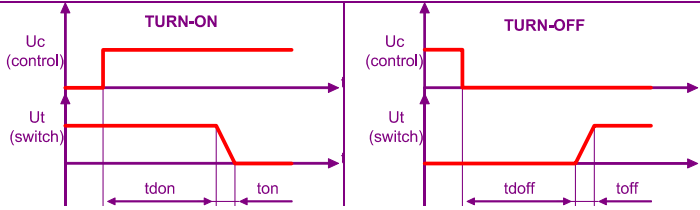
TIME CHARACT.	CHARACTERISTIC	LABEL	VALUE	 <p>For high frequency, take 2 x I<sub>e</sub> to calculate the heatsink; the protections must be chosen carefully. Please consult us if any.</p>
	Turn on time	<b>ton</b>	20µs	
	Turn on delay	<b>tdon</b>	20µs	
	Turn off time	<b>toff</b>	20µs	
	Turn off delay	<b>tdoff</b>	20µs	
Max. On-Off frequency	<b>F<sub>(on-off)</sub></b>	>1000Hz		

**POWER OUTPUT CHARACTERISTICS**

POWER CIRCUIT	CHARACTERISTIC	LABEL	VALUE	INFO.
	Nominal voltage	<b>U<sub>enom</sub></b>	<b>24VDC</b>	
	Voltage range	<b>U<sub>t</sub>   U<sub>e</sub></b>	<b>5-40VDC</b>	U <sub>tmax</sub> =40VDC
	Non-repetitive peak voltage	<b>U<sub>tp</sub></b>	75V	
	Overvoltage protection	<b>D1</b>	39V (Transient voltage suppressor)	1500W / 1ms See fig.10 & 11
	Off-state max reverse voltage drop (internal diode)	<b>-U<sub>t</sub></b>	0.92V	@I <sub>e</sub> =75A & @U <sub>c</sub> =0 See fig. 6
	Maximum nominal currents	<b>I<sub>e max</sub></b>	<b>Resistive</b> 60A	<b>Motor</b> Please contact us
	Max. non-repetitive peak current	<b>I<sub>epeak</sub></b>	Switch OFF D<1% 294A	Switch OFF F <sub>max</sub> 60A
	Min. load current	<b>I<sub>emin</sub></b>	5mA	ON-state 750A
	Max. leakage current	<b>I<sub>elk max</sub></b>	3mA	@T <sub>c</sub> =100°C @T <sub>j</sub> =175°C @U <sub>tp</sub> ( <b>See fig. 8</b> )
	Max. on-state resistance	<b>RD<sub>son</sub></b>	4.5mOhms @T <sub>j</sub> =25°C	8.2mOhms @T <sub>j</sub> =125°C
	Typ. output capacitance	<b>C<sub>out</sub></b>	1.5nF	@I <sub>emax</sub>
	Junction/case thermal resistance per power element	<b>R<sub>thjc</sub></b>	1.2K/W	@U <sub>tp</sub>
	Built-in heatsink thermal resistance vertically mounted	<b>R<sub>thra</sub></b>	10K/W	@ΔT <sub>ra</sub> =75°C
	Heatsink thermal time constant	<b>T<sub>thra</sub></b>	10 minutes	@ΔT <sub>ra</sub> =60°C
	Control inputs/power outputs insulation voltage	<b>U<sub>imp</sub></b>	2.5kV	
	Inputs/case insulation voltage	<b>U<sub>imp</sub></b>	2.5kV	
	Outputs/case insulation voltage	<b>U<sub>imp</sub></b>	2.5kV	
	Isolation resistance	<b>R<sub>io</sub></b>	1GΩ	
	Isolation capacitance	<b>C<sub>io</sub></b>	<8pF	
	Maximum junction temperature	<b>T<sub>jmax</sub></b>	175°C	
	Storage ambient temperature	<b>T<sub>stg</sub></b>	-40->+100°C	
	Operating ambient temperature	<b>T<sub>amb</sub></b>	-25->+90°C	<b>See fig. 9</b>
	Max. case temperature	<b>T<sub>c</sub></b>	100°C	

**OUTPUT SWITCH CHARACTERISTIC CURVES**

**Fig. 5 ON RESISTANCE VS JUNCTION TEMPERATURE**

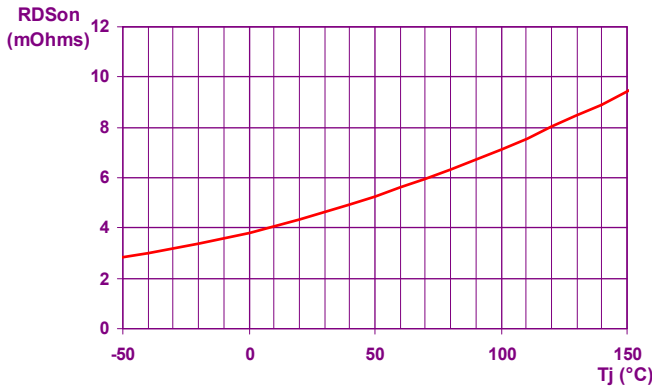

**Fig. 6 REVERSE VOLTAGE DROP VS REVERSE CURRENT**

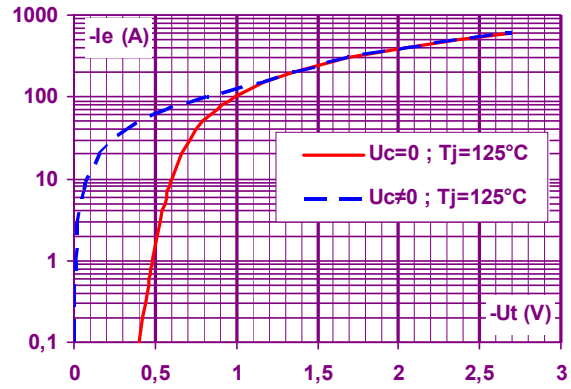

**Fig. 7 POWER ELEMENT TRANSIENT THERMAL IMPEDANCE vs. PULSE DURATION**

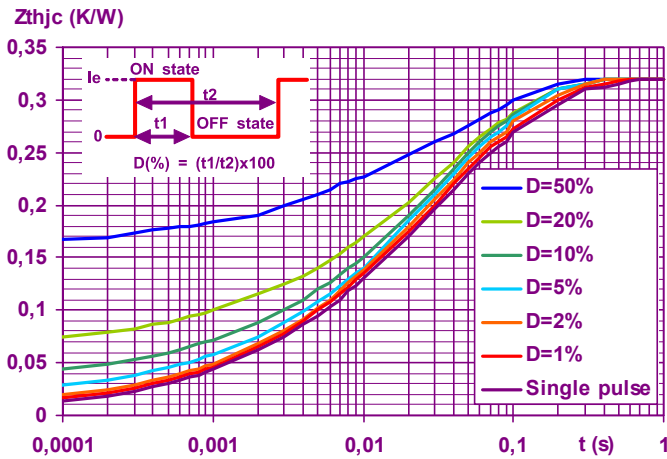

**Fig. 8 ON-STATE PEAK OVERLOAD CURRENT vs. PULSE DURATION**

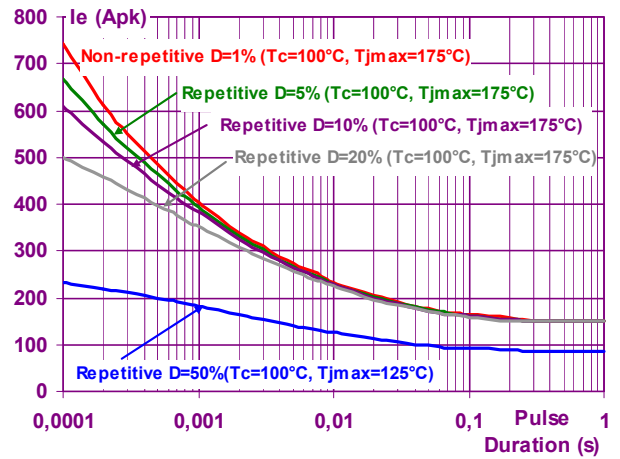

**Fig. 9 POWER DISSIPATED AND LOAD CURRENT LIMIT VS TEMPERATURE**

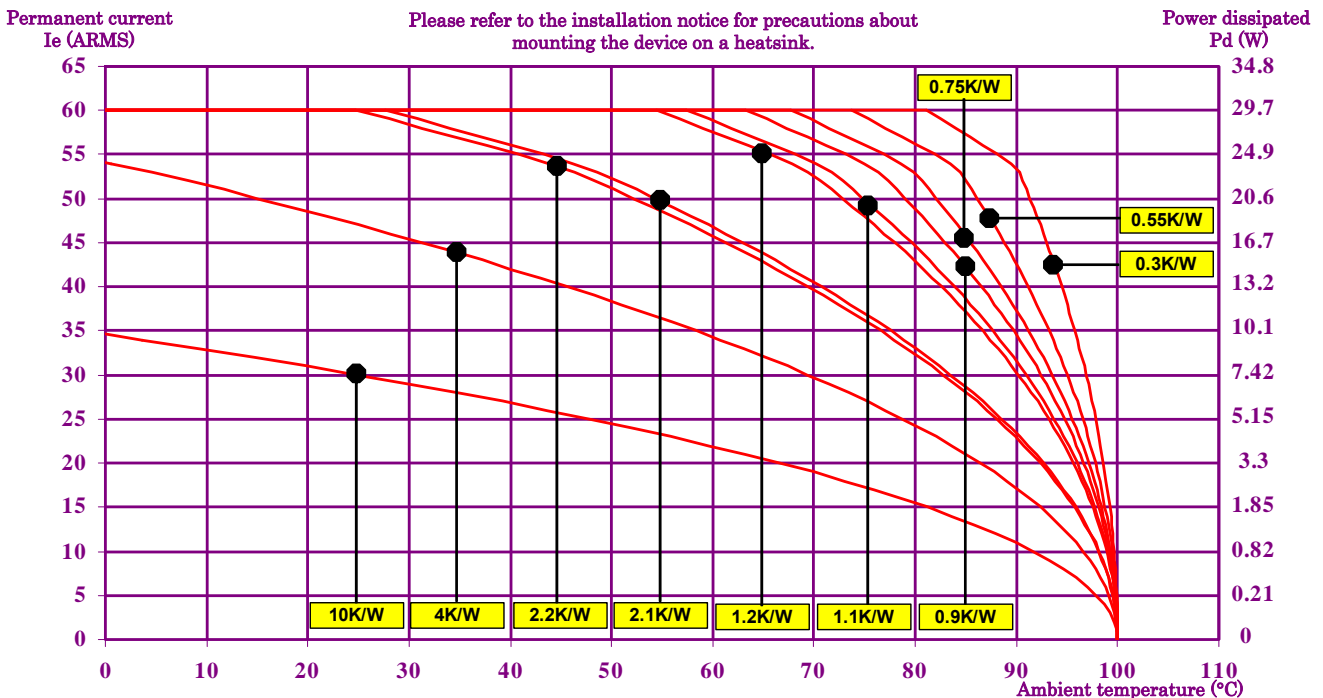

10K/W = No Heatsink / 1LD12020  
2.1K/W = WF210000  
0.9K/W = WF115100

4K/W = 150x150x3mm aluminium sheet  
1.2K/W = WF121000  
0.75K/W = WF070000

2.2K/W = WF262100 / WF151200  
1.1K/W = WF131100  
0.55K/W = WF050000

0.3K/W = WF031100

**BUILT-IN OVERVOLTAGE PROTECTION CHARACTERISTICS**

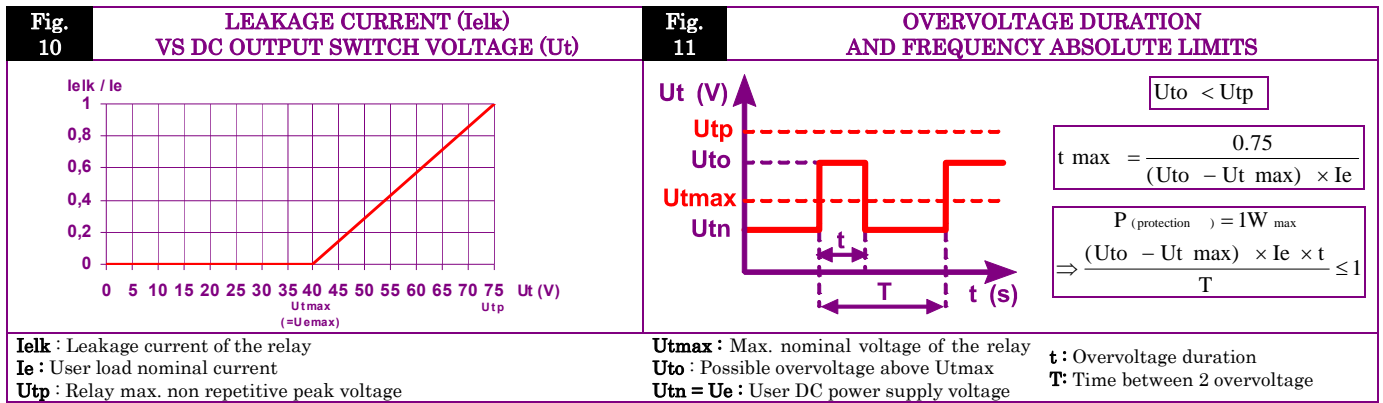

**t** : Overvoltage duration  
**T** : Time between 2 overvoltage

**GENERAL INFORMATION**

<b>MISC.</b>	<b>Display</b>		Green LED (indicates relay has switched ON)	
	<b>Housing</b>		UL94V0	
	<b>Mounting</b>		2 screws (M4x12mm ; tightening = 1.2N.m)	See mounting sheet
	<b>Noise level</b>		None	
	<b>Weight</b>		80g	

**STANDARDS**

<b>GENERAL</b>	<b>Standards</b>		IEC60947-1	
	<b>Protection level</b>		IP20	
	<b>Protection against direct touch</b>		Yes	
	<b>CE marking</b>		Yes	
	<b>UL, cULUS</b>		Yes	





<b>E.M.C. IMMUNITY</b>	TYPE OF TEST	STANDARD	LEVEL	EFFECT
	Fast transients bursts	EN61000-4-4	4kV criterion B	
	Electric chocks	EN61000-4-5	1kV criterion B	
	Voltage drop	EN61000-4-11	-	



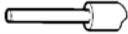

**CONNECTIONS**

Direct connection with wires with or without ferrules

With ring terminals

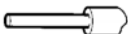

okpac <sup>®</sup>				Control wiring	
Number of wires				Screwdriver type	Recommended tightening torque M4 screw
1		2			
SOLID (No ferrule)	FINE STRANDED (With ferrule)	SOLID (No ferrule)	FINE STRANDED (With ferrule)		N.m
					
0,75 ... 2,5 mm <sup>2</sup> AWG18...AWG14	0,75 ... 2,5 mm <sup>2</sup> AWG18...AWG14	0,75 ... 2,5 mm <sup>2</sup> AWG18...AWG14	0,75 ... 2,5 mm <sup>2</sup> AWG18...AWG14	POZIDRIV 2	Mini 1,2 / Typ 1.5 / Max 2

okpac <sup>®</sup>				Power wiring	
Number of wires				Modèle de tournevis / Screwdriver type	Recommended tightening torque M5 screw
1		2			
SOLID (No ferrule)	FINE STRANDED (With ferrule)	SOLID (No ferrule)	FINE STRANDED (With ferrule)		N.m
					
1,5 ... 10 mm <sup>2</sup> AWG16...AWG8	1,5 ... 6 mm <sup>2</sup> AWG16...AWG10	1,5 ... 10 mm <sup>2</sup> AWG16...AWG8	1,5 ... 6 mm <sup>2</sup> AWG16...AWG10	POZIDRIV 2	Mini 2 / Typ 2.4 / Max 3

Power with ring terminals.

- W max = 12,6mm
- 16 mm<sup>2</sup> (AWG6)
- 25 mm<sup>2</sup> (AWG4)
- 35mm<sup>2</sup> (AWG2 / AWG3)
- 50mm<sup>2</sup> (AWG0 / AWG1)

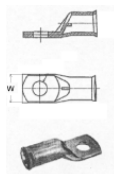

Suitable ring terminals and special kit for high current can be delivered: see high power SSR and data-sheet for power connection.

IP20 flaps

Flaps are delivered mounted on the relay.

Labels  
Marking labels are available, for mounting on flaps.  
Part number : 1MZ09000 (delivered per 200 parts)

FASTONS: Consult us



**DIMENSIONS AND ACCESSORIES**

Fig. 12

**DIMENSIONS (mm)**

CAD documents : [www.celduc-relais.com/uk/plan3D.asp](http://www.celduc-relais.com/uk/plan3D.asp)

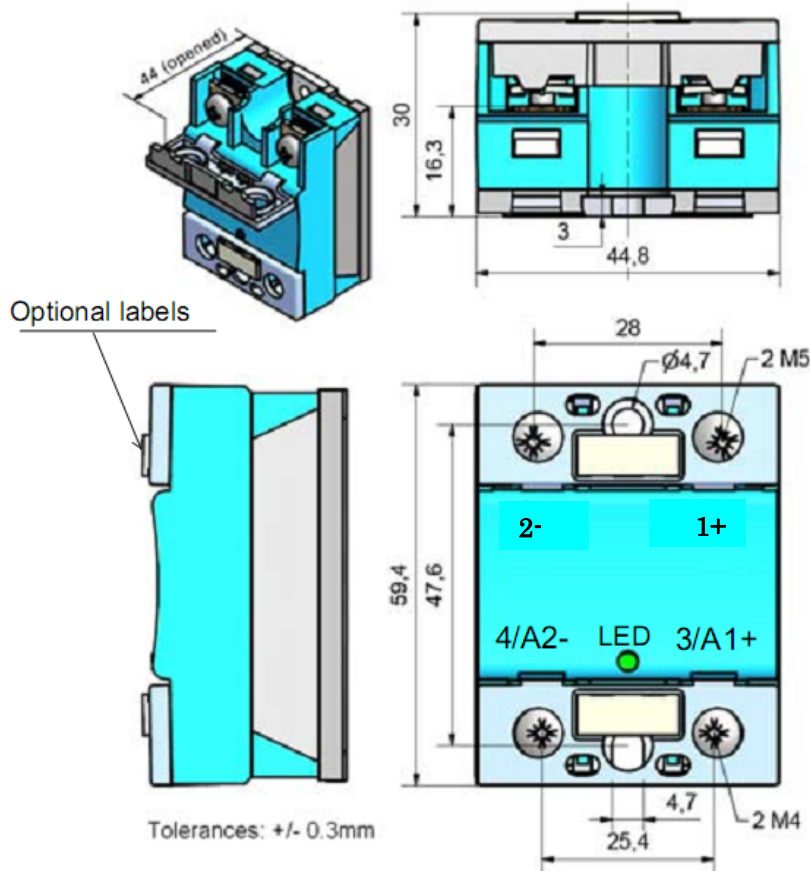

**ACCESSORIES**

**READY TO USE OVERVOLTAGE PROTECTION  
ESO01000**

(Please check our website for availability)

This device includes a diode (D2) and a capacitor (C1) suitable for most of the DC application.

To be mounted close to the SOM.

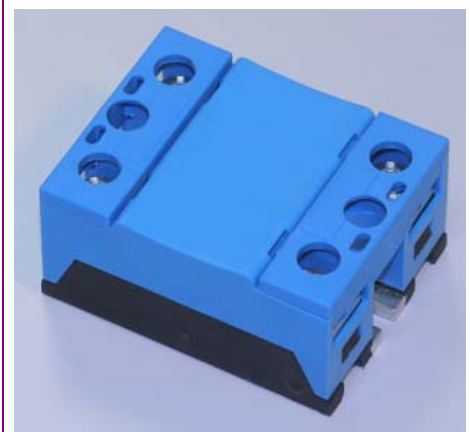

Please consult our website for other accessory references  
(Heatsinks, mounting adaptors, thermal grease...)