

HFE10

MINIATURE HIGH POWER LATCHING RELAY



File No.:E134517



Features

- 50A switching capability
- Lamp load up to 5000W
- Motor load up to 5HP
- Max. inrush current 500A/2ms
- Dielectric strength: more than 4kV (between coil and contacts)
- Manual switch function available
- Relays with 1.5mm contact gap are available
- Environmental friendly product (RoHS compliant)
- Outline Dimensions: (39.0 x 15.0 x 30.2)mm

CONTACT DATA

Contact arrangement	1A, 1B, 1C
Contact resistance	20mΩ max.(at 1A 24VDC)
Contact material	AgSnO ₂
Contact rating	1A, 1B: 50A 277VAC, 1 x 10 ⁵ OPS (Resistive) 5000W 240VAC, 3 x 10 ⁴ OPS (Incandescent lamp) 16A 277VAC, 6000 OPS (Electronic ballast) 5HP 277VAC, 3 x 10 ⁴ OPS (Motor) 1C: 40A 277VAC, 3 x 10 ⁴ OPS (Resistive)
Max. switching voltage	440VAC
Max. switching current	50A
Max. switching power	1A: 12500VA / 1C: 10000VA
Max. continuous current	50A
Mechanical endurance	1 x 10 ⁶ OPS
Electrical endurance	See rated load

COIL DATA

at 23°C

Nominal Voltage VDC	Set / Reset Voltage VDC max.	Pulse Duration ms min.	Coil Resistance x (1±10%) Ω	
6	4.8	50	Single coil latching	
9	7.2	50		24
12	9.6	50		54
24	19.2	50		96
48	38.4	50	384	
6	4.8	50	Double coils latching	
9	7.2	50		12+12
12	9.6	50		27+ 27
24	19.2	50		48+48
48	38.4	50		192+192
48	38.4	50		768+768

COIL

Coil power	Single coil latching: Approx. 1.5W Double coils latching: Approx. 3.0W
------------	---

CHARACTERISTICS

Insulation resistance	1000MΩ (at 500VDC)	
Dielectric strength	Between coil & contacts	4000VAC 1min
	Between open contacts	1500VAC 1min
Creepage distance (input to output)	1A, 1B: 8mm 1C: 6mm	
Set time (at nomi. volt.)	15ms max.	
Reset time (at nomi. volt.)	15ms max.	
Max. operate frequency	1A, 1B: 20cycles/min 1C: 10cycles/min	
Shock resistance	Functional	98m/s ²
	Destructive	980m/s ²
Vibration resistance	10Hz to 55Hz 1.5mm DA	
Humidity	5% to 85% RH	
Ambient temperature	-40°C to 70°C	
Termination	PCB	
Unit weight	Approx. 32g	
Construction	Plastic sealed, Flux proofed	

Notes: The data shown above are initial values.

SAFETY APPROVAL RATINGS

UL/CUL (AgSnO ₂)	1 Form A	Resistive: 50A 277VAC Incandescent lamp: 5000W 240VAC
	1 Form C	40A 277VAC
VDE	1 Form A 1 Form B	Resistive: 50A 277VAC

Notes: 1) All values unspecified are at room temperature.

2) Only some typical ratings are listed above. If more details are required, please contact us.



HONGFA RELAY

ISO9001, ISO/TS16949, ISO14001, OHSAS18001, IECQ QC 080000 CERTIFIED

2016 Rev. 1.10

ORDERING INFORMATION

Type	HFE10 -1/ 12 -D 1 S T -L2 -R (W) (XXX)							
Version	1: No auxiliary convexity, no manual switch 2: No auxiliary convexity, with manual switch 3: With auxiliary convexity, no manual switch 4: With auxiliary convexity, with manual switch 5: No auxiliary convexity, with manual switch, the reverse action							
Coil voltage	6, 9, 12, 24, 48VDC							
Contact form	1) H: 1 Form A D: 1 Form B (No UL approval) Z: 1 Form C (No for HFE10-5) (No VDE approval)							
Termination	1: Extra long terminal 5: Wide terminal 2) 6: Bending extra long terminal 7: Double PCB terminal Nil: PCB terminal							
Construction	3) S: Plastic sealed (Only for HFE10-1 & HFE10-3) Nil: Flux proofed							
Contact material	T: AgSnO ₂							
Sort	L1: Single coil latching				L2: Double coils latching			
Polarity	R: Negative polarity				Nil: Positive polarity			
Customer special code	(W): Relays with 1.5mm contact gap (Only for H model. No approval.) Nil: Standard type							
Special code	(XXX): Customer special requirement				Nil: Standard			

Notes: 1) H means that relay is on the "reset" status when delivery; D means that relay is on the "set" status when delivery.

2) The 1 type, 5 type, 6 type and 7 type is only for HFE10-1/□□□H, HFE10-2/□□□H.

3) If water cleaning is required after the relay is assembled on PCB, please contact us for suggestion about suitable parts.

4) The customer special requirement express as special code after evaluating by Hongfa. e.g. (399) stands for Special polarity (See Wiring Diagram).

OUTLINE DIMENSIONS AND WIRING DIAGRAM

Unit: mm

Outline Dimensions

HFE10-1, HFE10-2, HFE10-3, HFE10-4

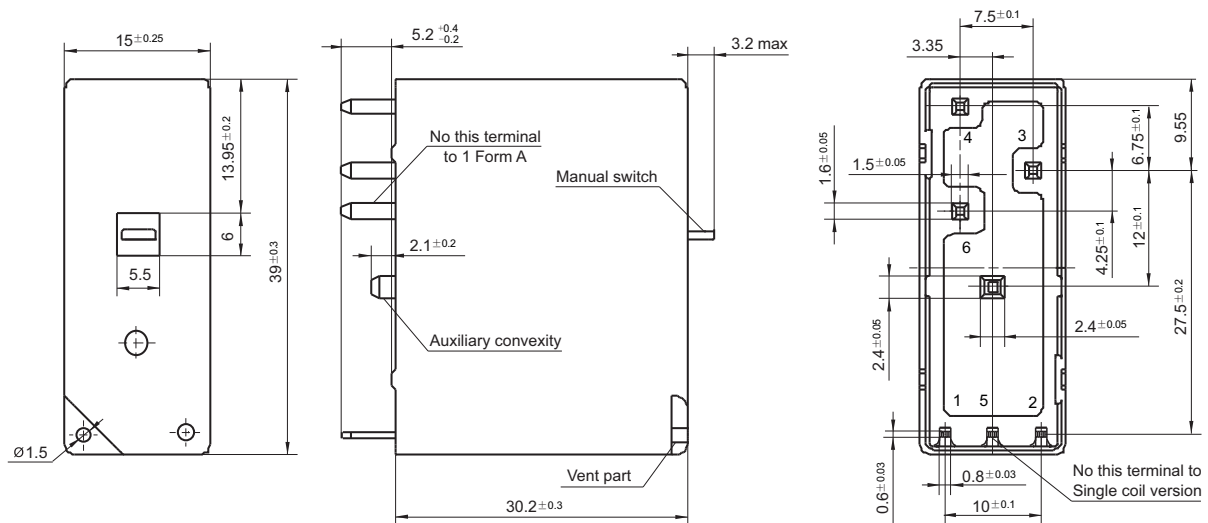

(Bottom view)

Outline Dimensions

HFE10-1/ □□□ H5

HFE10-2/ □□□ H5

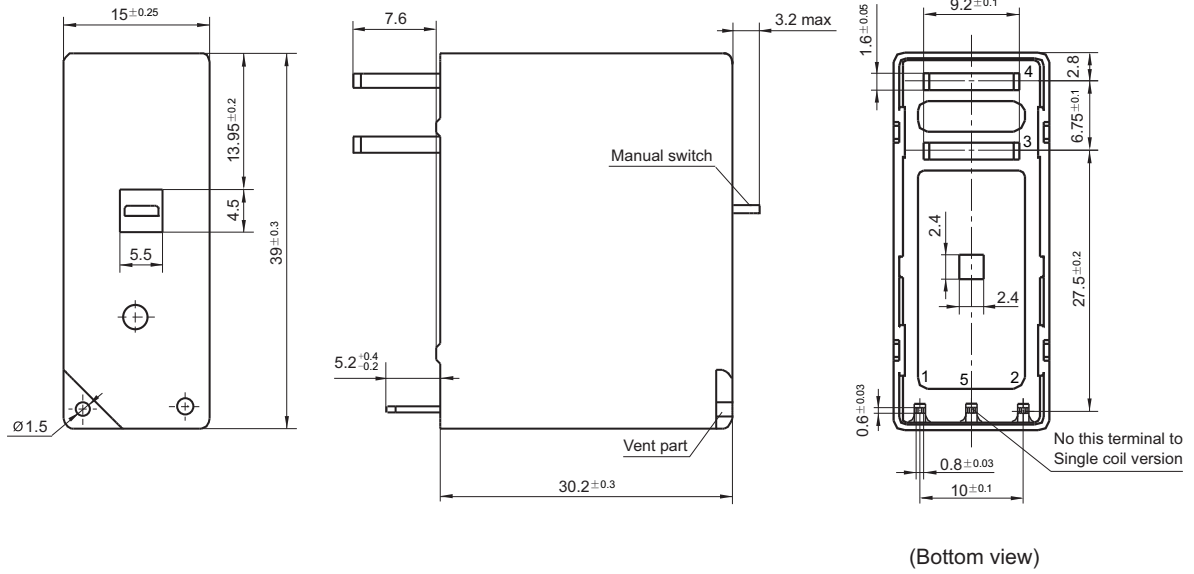

HFE10-1/ □□□ H1

HFE10-2/ □□□ H1

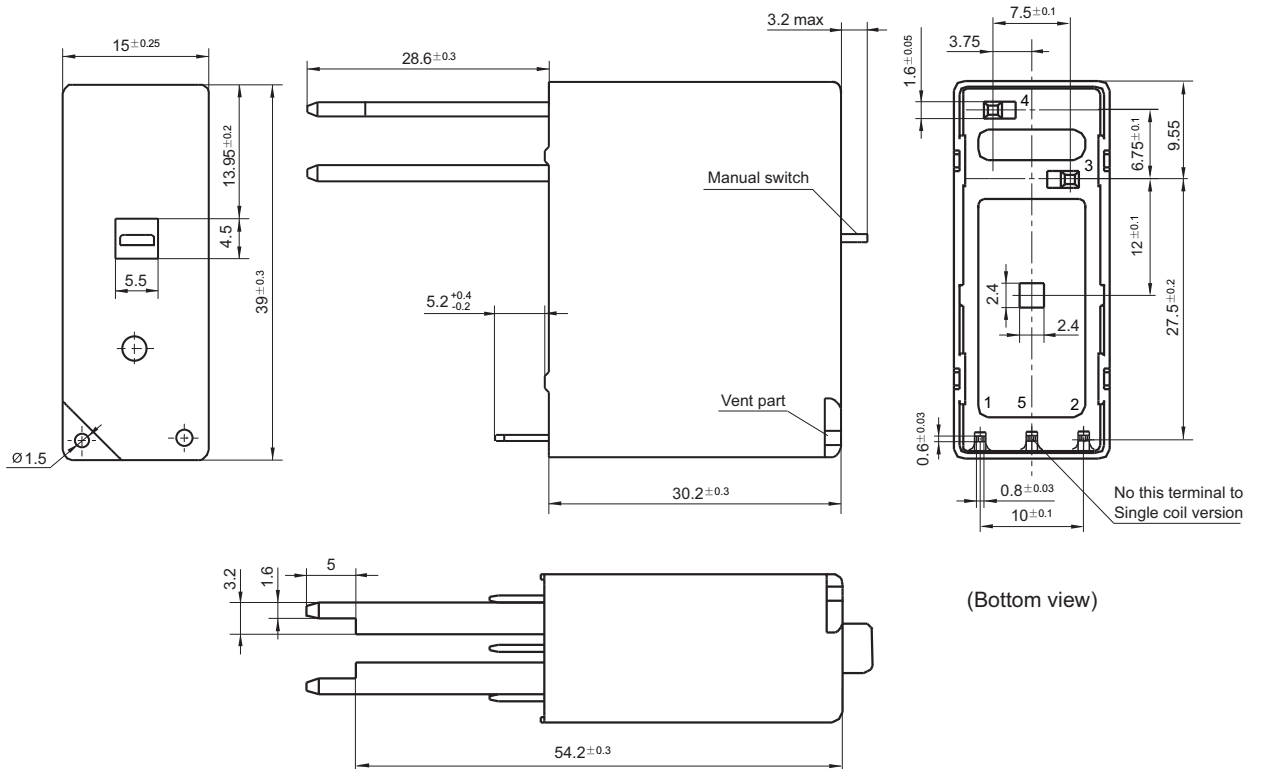

Outline Dimensions

HFE10-1/ □□□ H6

HFE10-2/ □□□ H6

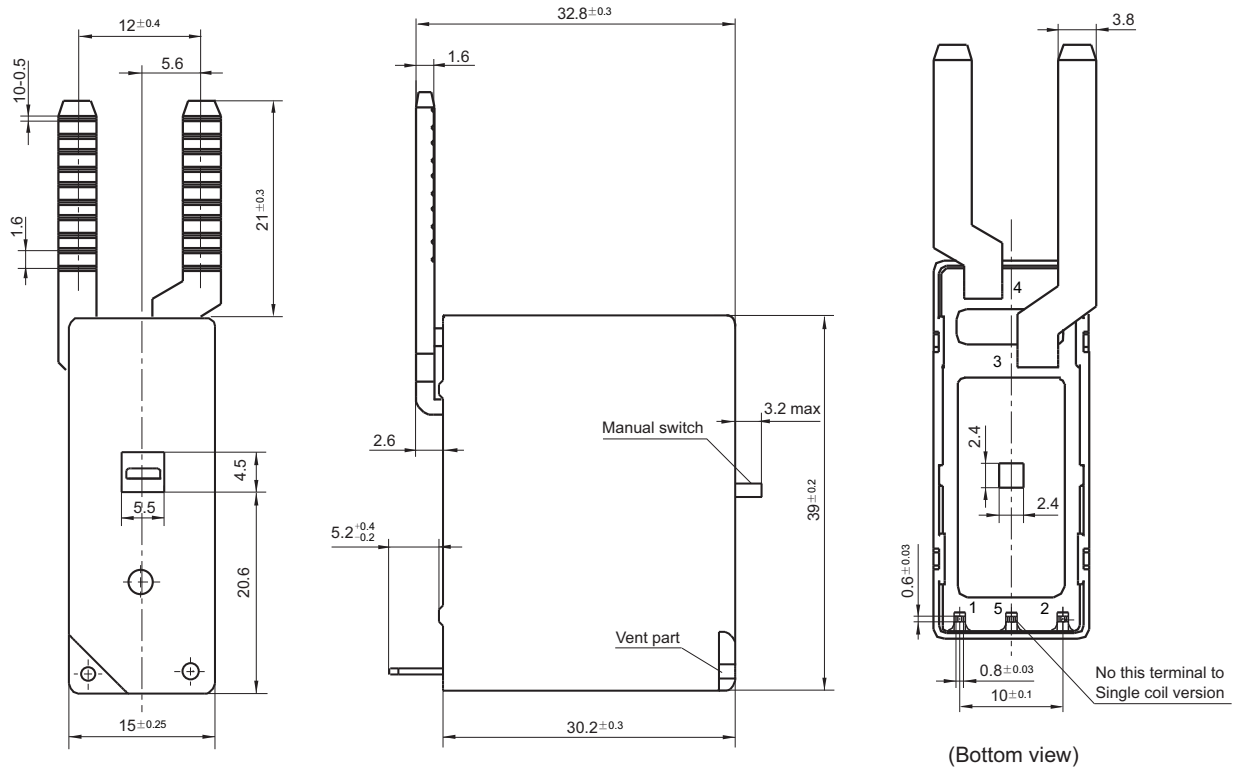

HFE10-5/ □□□ H

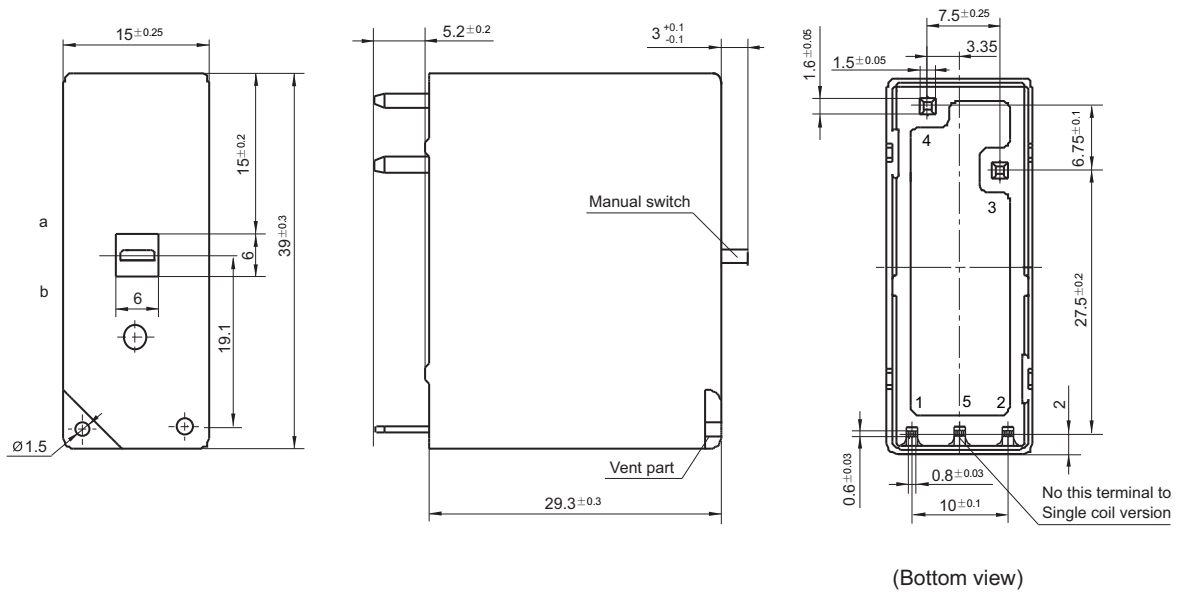

Remark: When the manual switch is pitched on point a, the contact is open; when the manual switch is pitched on point b, the contact is closed.

Outline Dimensions

HFE10-1/ □□□ H7
 HFE10-2/ □□□ H7

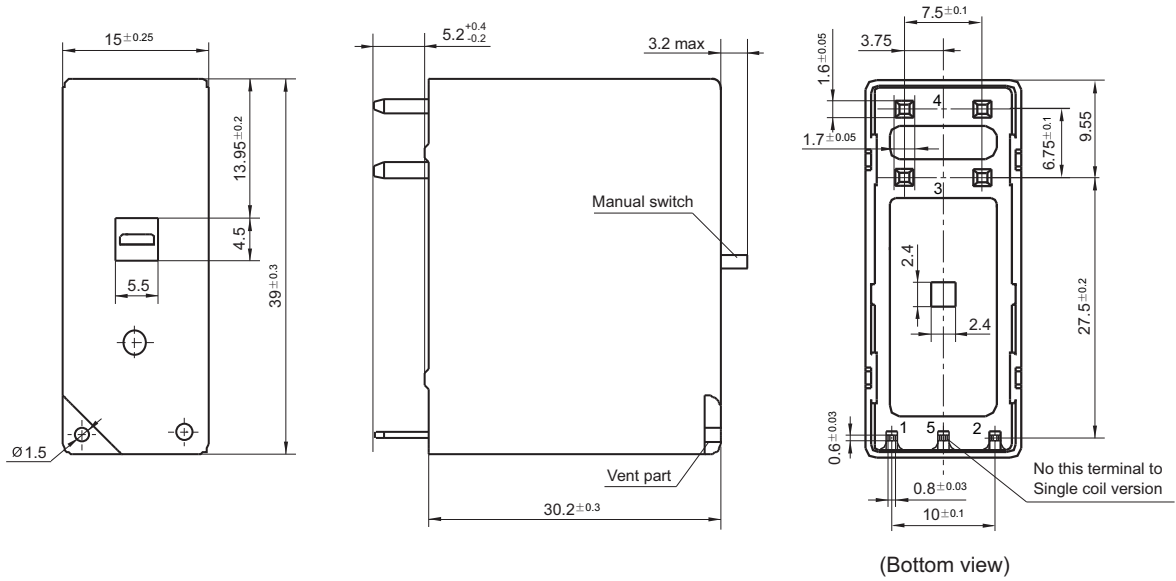

Remark: In case of no tolerance shown in outline dimension: outline dimension ≤ 1 mm, tolerance should be ± 0.2 mm; outline dimension > 1 mm and ≤ 5 mm, tolerance should be ± 0.3 mm; outline dimension > 5 mm, tolerance should be ± 0.4 mm.

Wiring Diagram

HFE10-1, HFE10-2, HFE10-3, HFE10-4

Positive polarity

Single coil latching, 1 Form A Double coils latching, 1 Form A Single coil latching, 1 Form B Double coils latching, 1 Form B

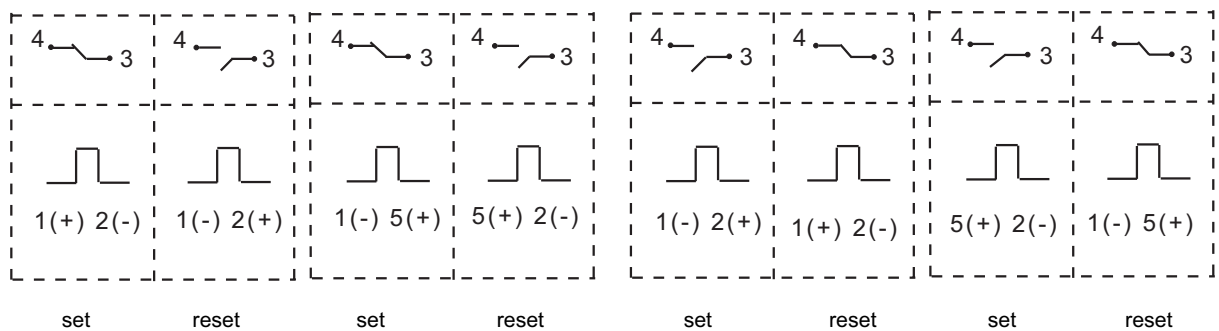

OUTLINE DIMENSIONS AND WIRING DIAGRAM

Unit: mm

Single coil latching, 1 Form C Double coils latching, 1 Form C

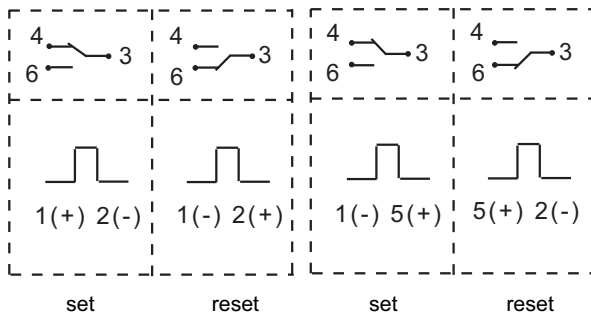

Negative polarity

Single coil latching, 1 Form A Double coils latching, 1 Form A

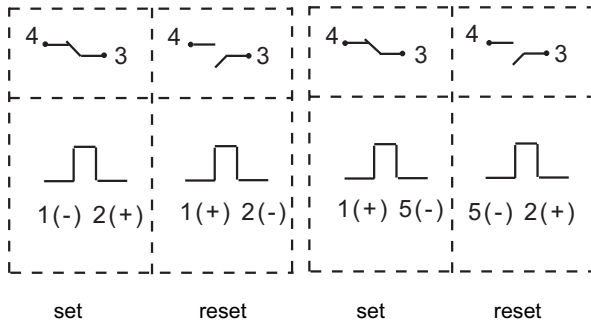

Single coil latching, 1 Form C Double coils latching, 1 Form C

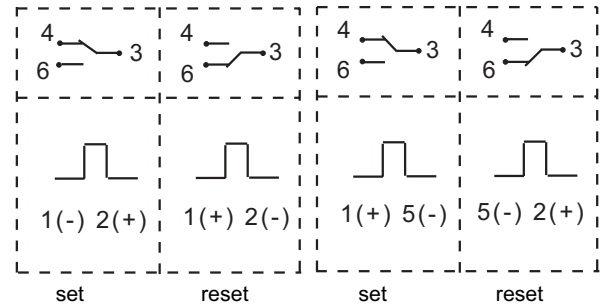

Single coil latching, 1 Form B Double coils latching, 1 Form B

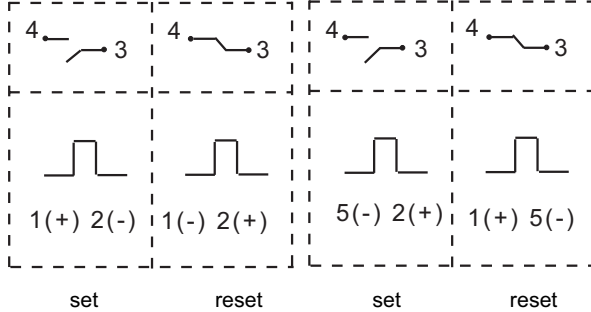

HFE10-5

Positive polarity

Single coil latching, 1 Form A Double coils latching, 1 Form A

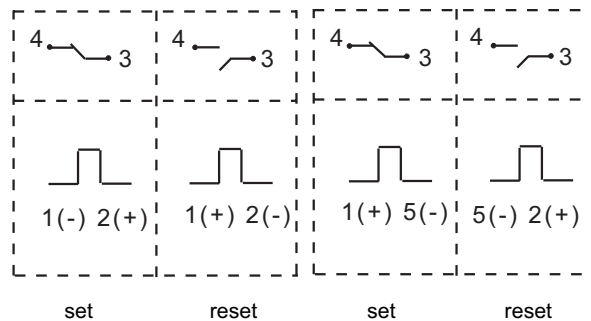

Single coil latching, 1 Form B Double coils latching, 1 Form B

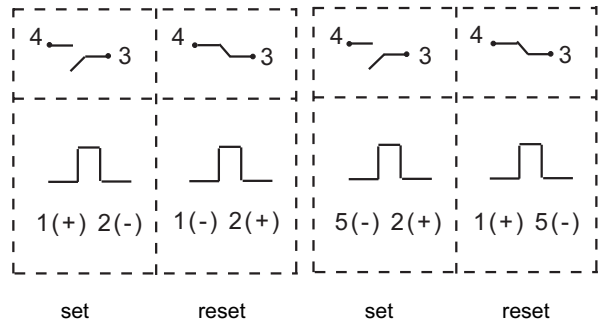

Wiring Diagram

Negative polarity

Single coil latching, 1 Form A

Double coils latching, 1 Form A

Single coil latching, 1 Form B

Double coils latching, 1 Form B

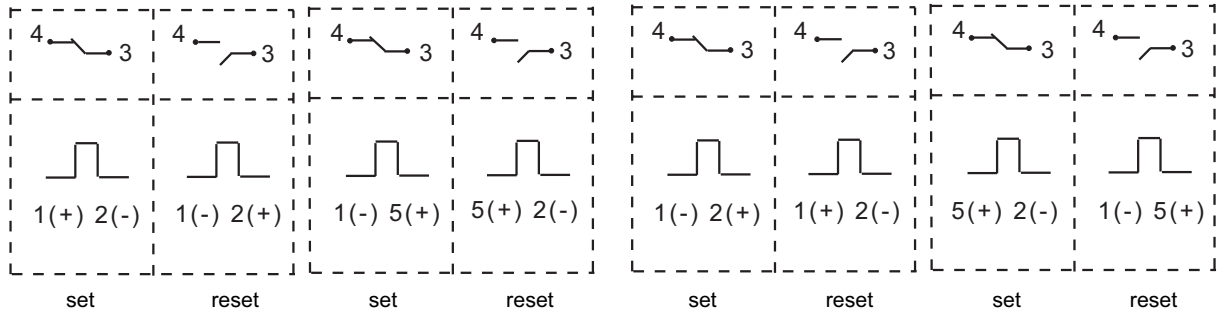

HFE10-1, HFE10-2, HFE10-3, HFE10-4, HFE10-5

(399):Special polarity

Double coils latching

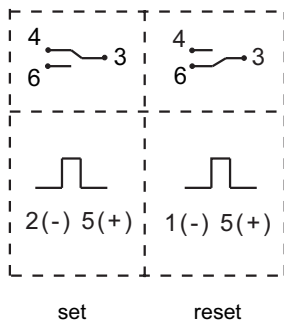

Notice:

1. When choose the relay with PCB termination, the recommended welding temperature range and duration is 240°C to 260°C, 2s to 5s; Please do not use the reflow welding method, if the reflow is really required, please contact our technicals; the normal recommended wave soldering temperature is 250°C within 2s.
2. Relay is on the "reset" or "set" status when being released from stock, with the consideration of shock risen from transit and relay mounting, relay would be changed to "set" or "reset" status, therefore, when application (connecting the power supply), please reset the relay to "set" or "reset" status on request.
3. In order to maintain "set" or "reset" status, energized voltage to coil should reach the rated voltage, impulse width should be 5 times more than "set" or "reset" time. Do not energize voltage to "set" coil and "reset" coil simultaneously. And also long energized time (more than 1 min) should be avoided.

Disclaimer

The specification is for reference only. Specifications subject to change without notice.

We could not evaluate all the performance and all the parameters for every possible application. Thus the user should be in a right position to choose the suitable product for their own application. If there is any query, please contact Hongfa for the technical service. However, it is the user's responsibility to determine which product should be used only.

© Xiamen Hongfa Electroacoustic Co., Ltd. All rights of Hongfa are reserved.